

RoHS



■ Specifications

- Voltage rating: 250V AC / DC
- Current rating: 0.5A AC / DC
- Withstanding voltage: 500V AC/minute
- Temperature range: -25° ~ +85°
- Insulation resistance: ≥100MΩ
- Contact resistance: ≤30mΩ
- After environmental testing: ≤40mΩ

1276 H I-2*XX X-XX XX

① ② ③ ④ ⑤ ⑥ ⑦

- ① Series No.
- ② Category: H-HSG
- ③ Appearance type:
I-HSG and Hardware assembly
- ④ Row No.-Pin No.: 2*XX-Double Row
- ⑤ Plug the Pin & special No.:
Blank-Two-Piece, Contact Gold Flash;
G15-Two-Piece, Contact Gold 15u";
G30-Two-Piece, Contact Gold 30u"
- ⑥ Material: 46-PA46 94V-0; PT-PBT UL 94V-0
- ⑦ Color: Blank : Natural Color

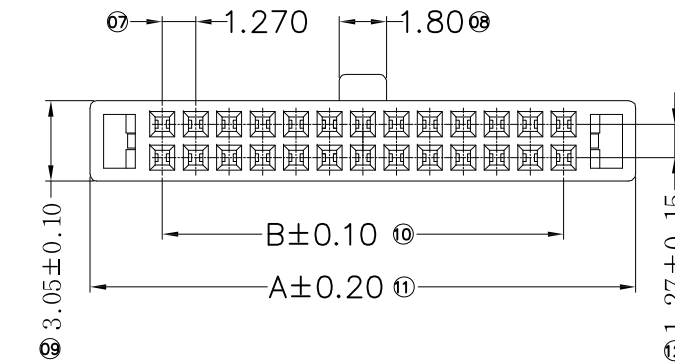
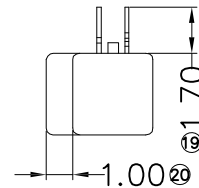
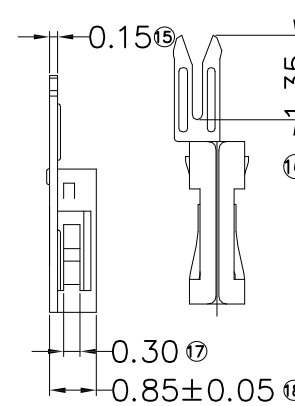
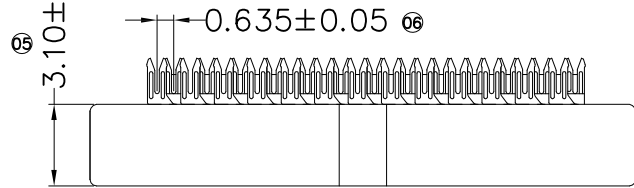
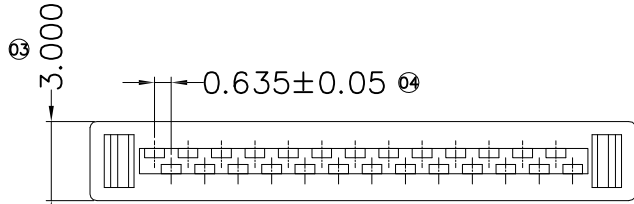
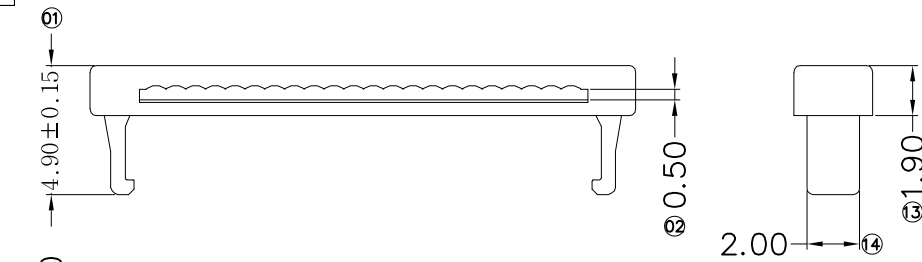

Poles	Dimensions (mm)		Poles	Dimensions (mm)		Poles	Dimensions (mm)	
	A	B		A	B		A	B
2*03	8.00	2.54	2*10	16.89	11.43	2*21	30.86	25.40
2*04	9.27	3.81	2*12	18.16	12.70	2*22	32.13	26.67
2*05	10.54	5.08	2*13	20.70	15.24	2*25	35.94	30.48
2*06	11.81	6.35	2*14	21.97	16.51	2*26	37.21	31.75
2*07	13.08	7.62	2*15	23.24	17.78	2*30	42.29	36.83
2*08	14.35	8.89	2*17	25.78	20.32	2*32	44.83	39.37
2*09	15.62	10.16	2*20	29.59	24.13			

1276HI-2*XX-46	Nylon 46 UL 94V-0	Nylon 46 UL 94V-0	Phosphor Bronze	Contact Gold-Flash	1276T
1276HI-2*XXG30-PT	PBT UL 94V-0	PBT UL 94V-0		Contact Gold 30u"	
1276HI-2*XXG15-PT	PBT UL 94V-0	PBT UL 94V-0		Contact Gold 15u"	
1276HI-2*XX-PT	PBT UL 94V-0	PBT UL 94V-0		Contact Gold-Flash	
PART NO	Material	Material(Cover)	Material(Terminal)	Finish(Terminal)	Suitable GYA Terminal

GENERAL TOLERANCE

.X ±0.30

.XX ±0.20

.XXX ±0.10

X.* ±2°

PROJECT

⊕ ⊖



东莞市国亚电子有限公司
Dong Guan Guo Ya Connectors co., Ltd.

PARTNO.

1276HI-2*XXXX-XX

TITLE

1.27 mm Crimp Style Connector

APPROVAL CHECK DRAWN DATE

Yangzhengguo Yangzhengyi Lviansheng 2016/08/26

UNIT SCALE SHEET REV NUMBER

mm 1:1 1/1 A0 A-082

DATE	REV	ECN NO	DESCRIPTION	MODIFY	APPROVAL
1					
2					
3					
4					
5					

RoHS

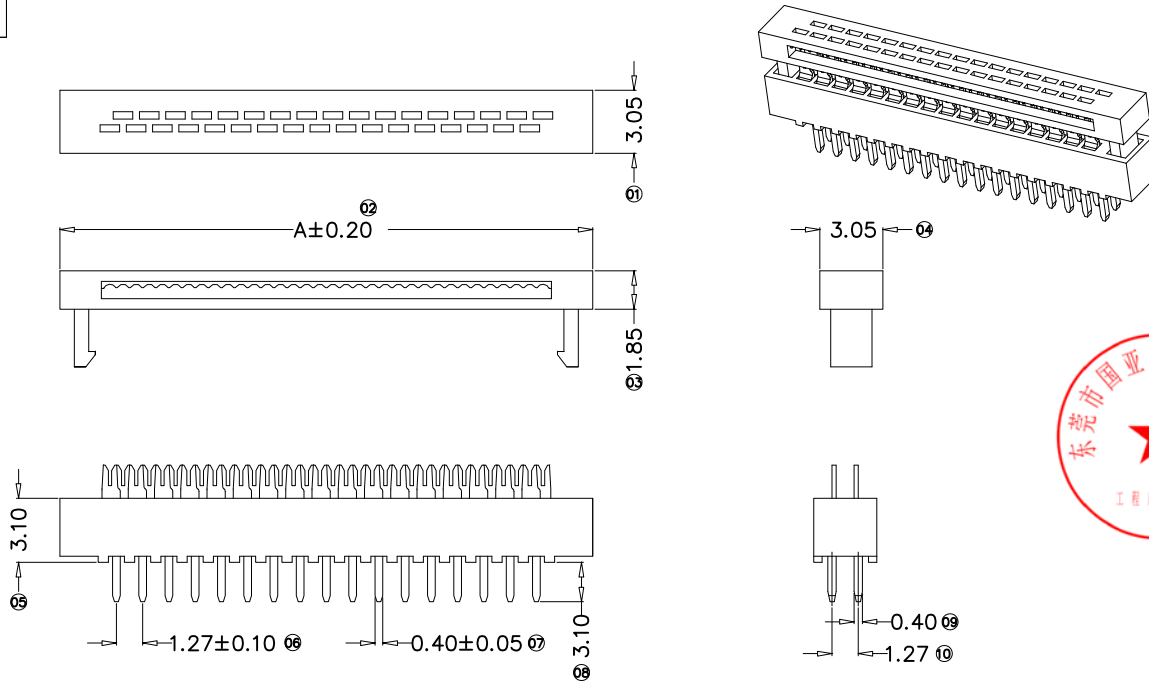

Specifications

- Voltage rating: 250V AC / DC
- Current rating: 0.5A AC / DC
- Withstanding voltage: 250V AC/minute
- Temperature range: -25° ~ +85°
- Insulation resistance: ≥100MΩ
- Contact resistance: ≤30mΩ
- After environmental testing: ≤40mΩ

1276 H D V-2*XX X-PTB XX XX
① ② ③ ④ ⑤ ⑥ ⑦ ⑧ ⑨

- ① SeriesNo.
- ② Category: H-HSG
- ③ WeldingWay: D-DIP
- ④ WeldingBoardAngle: V-180°
- ⑤ Row No.-Pin No.: XX-04P~26P
- ⑥ Plug the Pin & specialNo.:
- ⑦ Material: PT-PBT 94V-0 B-Brass
- ⑧ Plating Category:
G-Gold-Plated Contact *01-Gold Flash
SN-Bright tin plating
- ⑨ Color: Blank-natural color

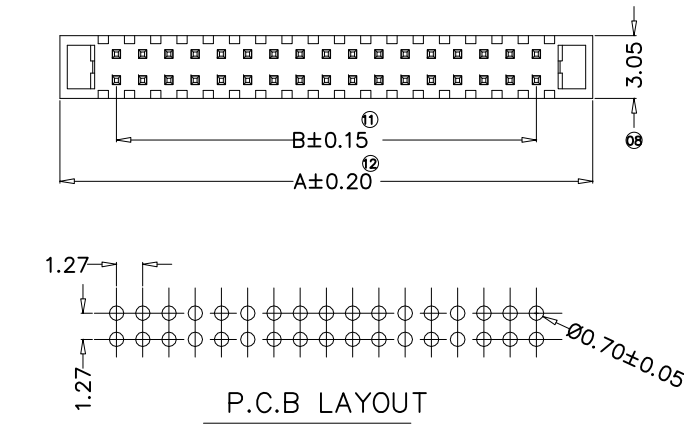

Poles	Dimensions(mm)		Poles	Dimensions(mm)	
	A	B		A	B
2*03	8.00	2.54	2*13	20.70	15.24
2*04	9.27	3.81	2*15	23.24	17.78
2*05	10.54	5.08	2*17	25.78	20.32
2*06	11.81	6.35	2*20	29.59	24.13
2*07	13.08	7.62	2*22	32.13	26.67
2*08	14.35	8.89	2*25	35.94	30.48
2*09	15.62	10.16	2*30	42.29	36.83
2*10	16.89	11.43	2*32	44.83	39.37

1276HDV-2*XX-PTBG01	PBT UL 94V-0	Brass	Contact Area Gold Flash
1276HDV-2*XX-PTBSN			Tin-Plated
PART NO	Material	Material(Pin)	Finish(Pin)

GENERAL TOLERANCE						PARTNO.				
.X	±0.30	GYA 东莞市国亚电子有限公司 Connectors Dong Guan Guo Ya Connectors co., Ltd.				1276HDV-2*XX-PTBXX				
.XX	±0.20					TITLE				
.XXX	±0.10					1.27 mm Crimp Style Connectors				
X.*	±2°					APPROVAL	CHECK	DRAWN	DATE	
PROJECT		Yangzhengguo	Yangzhengyi	Lvtiansheng	2016/08/26	UNIT	SCALE	SHEET	REV	NUMBER
DATE	REV	ECN NO	DESCRIPTION	MODIFY	APPROVAL	mm	1:1	1/1	A0	A-106

RoHS

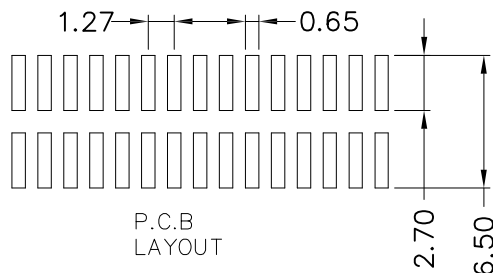
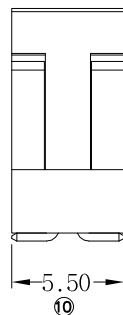
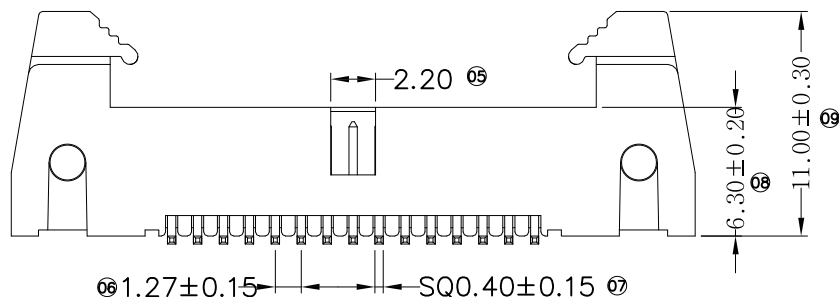
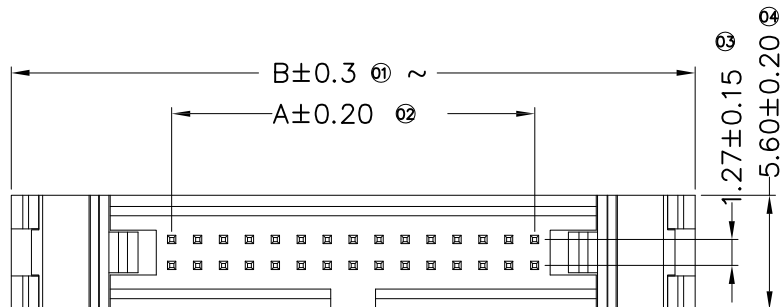

Poles	Dimensions (mm)		Poles	Dimensions (mm)	
	A	B		A	B
2*03	2.54	18.31	2*15	17.78	33.55
2*04	3.81	19.58	2*17	20.32	36.09
2*05	5.08	20.85	2*20	24.13	39.90
2*07	7.62	23.39	2*25	30.48	46.25
2*08	8.89	24.66	2*30	36.83	52.60
2*09	10.16	25.93	2*32	39.37	55.14
2*10	11.43	27.20	2*34	41.91	57.68
2*13	15.24	31.01			

Specifications

- Voltage rating: 250V AC / DC
- Current rating: 1A AC / DC
- Withstanding voltage: 500V AC/minute
- Temperature range: -40° ~ +105°
- Insulation resistance: ≥100MΩ
- Contact resistance: ≤20mΩ
- After environmental testing: ≤40mΩ

1276 K V S-2*XX A- XX XX XX
 ① ②③④ ⑤ ⑥ ⑦ ⑧ ⑨

- ① Series No.
- ② Category: K-Cowfish Longhorn Connector
- ③ Welding Board Angle: V- Straight 180°
- ④ Welding Way: S-SMT
- ⑤ Row No.-Pin No.: 2*XX-Double Row
- ⑥ Plug the Pin & Special No.:
 A-Cowfish Longhorn with Lock
- ⑦ Material: 6T-PA6T 94V-0; 9T-PA9T 94V-0
- ⑧ Planting Category: G**-Gold Plated Contact
 V**- All Gold-Plated
 01-Gold Flash 02-2u" 03-3u"
 05-5u" 10-10u" 15-15u"
 SN-Bright Tin Plating (70-120u")
 SN1-Bright Tin Plating (120u" Min).
 0-No Plating Material
 SW- Fog Tin Plating
- ⑨ Color: Blank-Natural Color

1276KVS-2*XXA-6TV01	PA6T UL 94V-0	Brass	Gold-Flash	1276H
1276KVS-2*XXA-9TV01	PA9T UL 94V-0			
PART NO	Material	Material(Pin)	Finish(Pin)	Mates With GYA Housing



东莞市国亚电子有限公司
 Dong Guan Guo Ya Connectors co., Ltd.

PARTNO.
 1276KVS-2*XX-XX-XX-XX

TITLE
 1.27 mm Crimp Style Connectors

APPROVAL	CHECK	DRAWN	DATE
Yangzhengguo	Yangzhengyi	Lvtiansheng	2016/08/26

UNIT	SCALE	SHEET	REV	NUMBER
mm	1:1	1/1	A0	A-022

DATE	REV	ECN NO	DESCRIPTION	MODIFY	APPROVAL
1					
2					
3					
4					
5					

GENERAL TOLERANCE	
.X	±0.30
.XX	±0.20
.XXX	±0.10
X.*	±2°
PROJECT	
⊕	□

RoHS

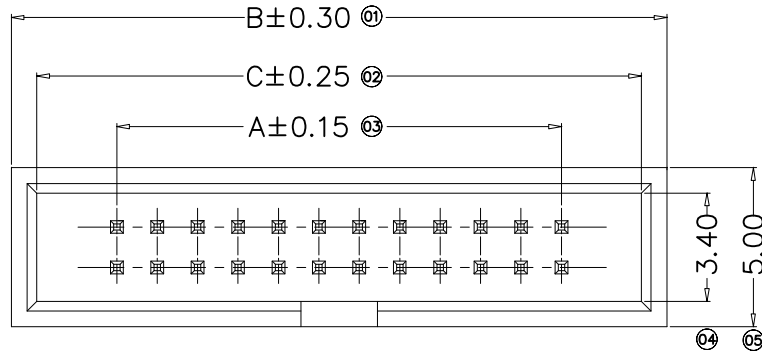

Specifications :

- Voltage rating: 250V AC / DC
- Current rating: 1.0A AC / DC
- Withstanding voltage: 300V AC/minute
- Temperature range: -25° ~ +85°
- Insulation resistance: ≥500MΩ
- Contact resistance: ≤20mΩ
- After environmental testing : ≤40mΩ
- Material(PIN): Brass
- Mates With GYA Housing: 1276H

1276 K V X- 2*XX X-LP V01 XX
 ① ② ③ ④ ⑤ ⑥ ⑦ ⑧ ⑨

- ① Series No.
- ② Category : K-Cowfish Longhorn Connector
- ③ Welding Board Angle : V-180°
- ④ Welding Way: Blank-DIP
- ⑤ Row No.-Pin No.: 2*XX-Double Row
- ⑥ Plug the Pin & Special No. :
- ⑦ Material: LP -LCP 94V-0
- ⑧ Plating Category: V01-Gold Flash
SN-Bright Tin Plating
- ⑨ Color : Blank-Natural Color

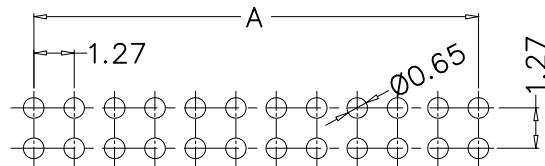
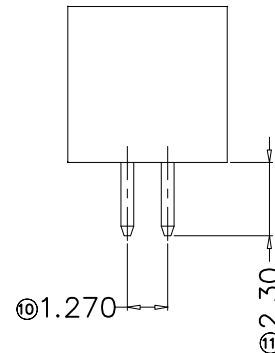
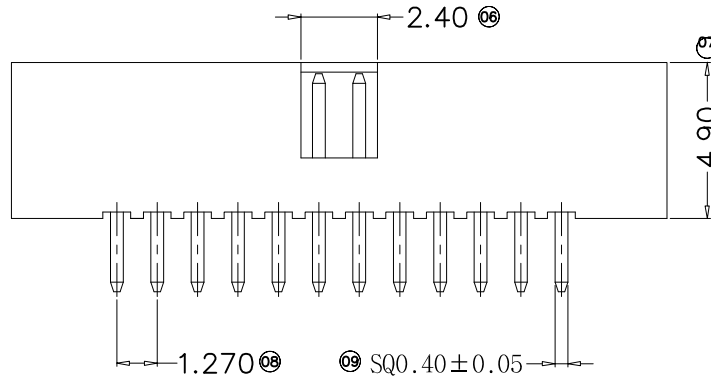

Recommended P.C.B Layout
 General Tolerance ±0.05

Poles	Dimensions (mm)			Poles	Dimensions (mm)		
	A	B	C		A	B	C
2*02	1.27	8.89	7.29	2*16	19.05	26.67	25.07
2*03	2.54	10.31	8.56	2*17	20.32	27.94	26.34
2*04	3.81	11.43	9.83	2*18	21.59	29.21	27.61
2*05	5.08	12.70	11.10	2*19	22.86	30.48	28.88
2*06	6.35	13.97	12.37	2*20	24.13	31.75	30.15
2*07	7.62	15.24	13.64	2*21	25.40	33.02	31.42
2*08	8.89	16.51	14.91	2*22	26.67	34.29	32.69
2*09	10.16	17.78	16.18	2*23	27.94	35.56	33.96
2*10	11.43	19.05	17.45	2*24	29.21	36.83	35.23
2*11	12.70	20.32	18.72	2*25	30.48	38.10	36.50
2*12	13.97	21.59	19.99	2*26	31.75	39.37	37.77
2*13	15.24	22.86	21.26	2*27	33.02	40.64	39.04
2*14	16.51	24.13	22.53	2*28	34.29	41.91	40.31
2*15	17.78	25.40	23.80	2*29	35.56	43.18	41.58

DATE	REV	ECN NO	DESCRIPTION	MODIFY	APPROVAL
1					
2					
3					
4					

GENERAL TOLERANCE	
.X	±0.30
.XX	±0.20
.XXX	±0.10
X.*	±2°
PROJECT	
①	②



东莞市国亚电子有限公司
 Dong Guan Guo Ya Connectors co., Ltd.

APPROVAL	CHECK	DRAWN	DATE
Yangzhengguo	Yangzhengyi	Lvtiansheng	2016/08/26

PARTNO.				
1276KV-2*XX-LPV01				
TITLE				
1.27 mm Crimp Style Connector				
UNIT	SCALE	SHEET	REV	NUMBER
mm	1:1	1/1	A0	A-268

RoHS

Specifications

- Voltage rating: 250V AC / DC
- Current rating: 1A AC / DC
- Withstanding voltage: 500V AC/minute
- Temperature range: -40° ~ +105°
- Insulation resistance: ≥100MΩ
- Contact resistance: ≤20mΩ
- After environmental testing: ≤40mΩ

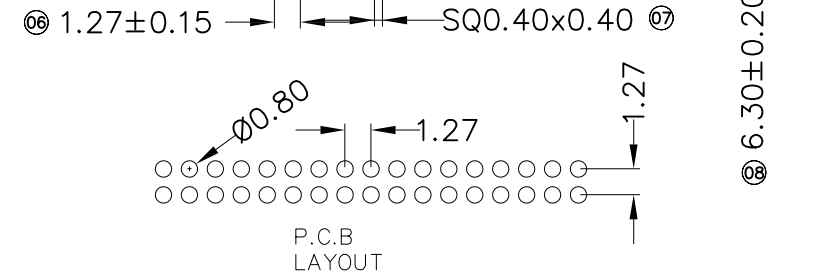
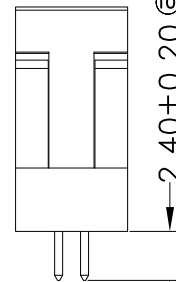
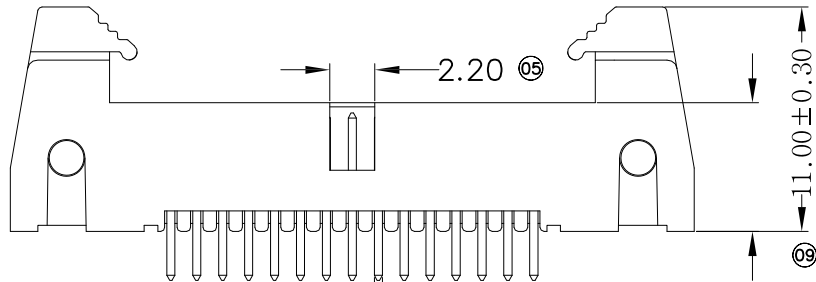
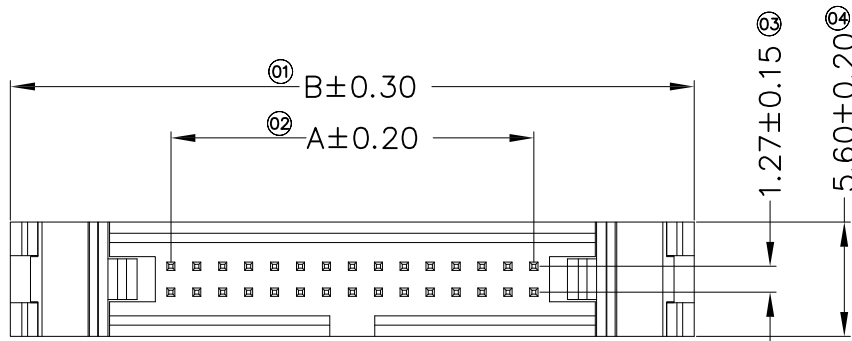

1276 K V X- 2*XX A-XX XX XX
 ① ② ③ ④ ⑤ ⑥ ⑦ ⑧ ⑨

- ① Series No.
- ② Category : K-Cowfish Longhorn Connector
- ③ Welding Board Angle : V-180° ; R-90°
- ④ Welding Way: Blank-DIP ; S-SMT
- ⑤ Row No.-Pin No.: XX-Single Row ; 2*XX-Double Row
- ⑥ Plug the Pin & Special No. : A-Cowfish Longhorn with Lock
- ⑦ Material: 6T-PA6T 94V-0; 9T-PA9T 94V-0
- ⑧ Plating Category: G**-Gold Plated Contact
 V**- All Gold-Plated
 01-Gold Flash 02-2u" 03-3u"
 05-5u" 10-10u" 15-15u"
 SN-Bright Tin Plating (70-120u")
 SN1-Bright Tin Plating (120u" Min)
 0-No Plating Material
 SW- Fog Tin Plating
 HS-Hight temperature Tin
- ⑨ Color : Blank-Natural Color

Poles	Dimensions (mm)	
	A	B
06	2.54	18.31
08	3.81	19.58
10	5.08	20.85
14	7.62	23.39
16	8.89	24.66
18	10.16	25.93
20	11.43	27.20
26	15.24	31.01
30	17.78	33.55
34	20.32	36.09
40	24.13	39.90
50	30.48	46.25
60	36.83	52.60
64	39.37	55.14
68	41.91	57.68

1276KV-2*XX-A-6T-V01-X	PA6T UL 94V-0	Brass	Gold-Flash	1276H	1,000Pcs
PART NO	Material	Material(Pin)	Finish(Pin)	Mates With GYA Housing	Q'ty/Bag

DATE	REV	ECN NO	DESCRIPTION	MODIFY	APPROVAL
1					
2					
3					
4					

GENERAL TOLERANCE	
.X	±0.30
.XX	±0.20
.XXX	±0.10
X.*	±2°
PROJECT	
⊕	□

	东莞市国亚电子有限公司 Dong Guan Guo Ya Connectors co., Ltd.			
	APPROVAL	CHECK	DRAWN	DATE
	Yangzhengguo	Yangzhengyi	Lvtiansheng	2016/08/26

PARTNO.				
1276KV-2*XX-A-XX-XX-X				
TITLE				
1.27mm Crimp Style Connectors				
UNIT	SCALE	SHEET	REV	NUMBER
mm	1:1	1/1	A0	A-213

RoHS

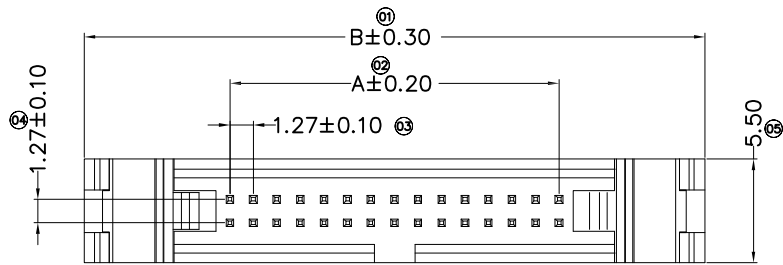

Specifications

- Voltage rating: 250V AC / DC
- Current rating: 0.5A AC / DC
- Withstanding voltage: 500V AC/minute
- Temperature range: -25° ~ +85°
- Insulation resistance: ≥100MΩ
- Contact resistance: ≤30mΩ
- After environmental testing : ≤40mΩ

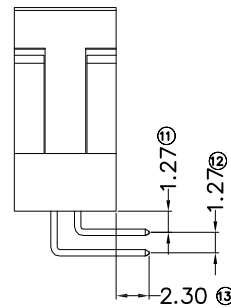
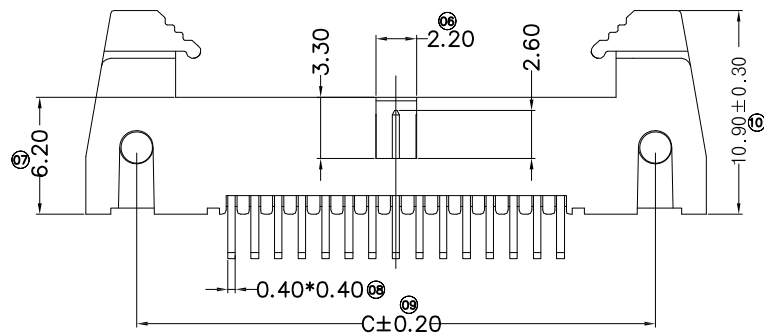

1276 K R X-2*XX A-PT V01 XX
① ② ③ ④ ⑤ ⑥ ⑦ ⑧ ⑨

- ① Series No.
- ② Category : K-Cowfish Longhorn Connector
- ③ Welding Board Angle : V-180° ; R-90°
- ④ Welding Way: Blank-DIP ; S-SMT
- ⑤ Row No.-Pin No.: XX-Single Row ; 2*XX-Double Row
- ⑥ Plug the Pin & Special No. : A-Cowfish Longhorn with Lock
- ⑦ Material: PT -PBT 94V-0
- ⑧ Plating Category: G**-Gold Plated Contact
V**- All Gold-Plated
01-Gold Flash 02-2u" 03-3u"
05-5u" 10-10u" 15-15u"
SN-Bright Tin Plating (70-120u")
SN1-Bright Tin Plating (120u" Min).
0-No Plating Material
SW- Fog Tin Plating
HS-Hight temperature Tin
- ⑨ Color : Blank-Natural Color

Poles	Dimensions (mm)		
	A	B	C
06	2.54	18.31	12.81
08	3.81	19.58	14.08
10	5.08	20.85	15.35
14	7.62	23.39	17.89
16	8.89	24.66	19.16
18	10.16	25.93	20.43
20	11.43	27.20	21.70
26	15.24	31.01	25.51
30	17.78	33.55	28.05
34	20.32	36.09	30.59
40	24.13	39.90	34.40
50	30.48	46.25	40.75
60	36.83	52.60	47.10
64	39.37	55.14	49.64
68	41.91	57.68	52.18

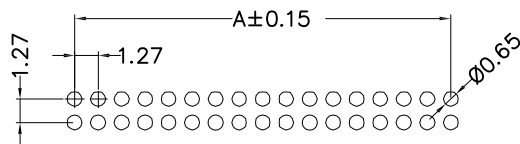

P.C.B Board Layout

1276KR-2*XXA-PTV01	PAGT UL 94V-0	Brass	Gold-Flash	1276HI	1,000Pcs
PART NO	Material	Material(Pin)	Finish(Pin)	Mates With GYA Housing	Q'ty/Bag

GENERAL TOLERANCE						PARTNO. 1276KR-2*XXA-PTV01				
.X ±0.30						TITLE 1.27 mm Crimp Style Connector				
.XX ±0.20										
.XXX ±0.10						UNIT SCALE SHEET REV NUMBER				
X.* ±2°										
DATE	REV	ECN NO	DESCRIPTION	MODIFY	APPROVAL	PROJECT	APPROVAL	CHECK	DRAWN	DATE
1						Yangzhengguo	Yangzhengyi	Lvtiansheng		2016/08/26



东莞市国亚电子有限公司
Dong Guan Guo Ya Connectors co., Ltd.

PARTNO. 1276KR-2*XXA-PTV01

TITLE 1.27 mm Crimp Style Connector

UNIT	SCALE	SHEET	REV	NUMBER
mm	1:1	1/1	A0	A-082

RoHS

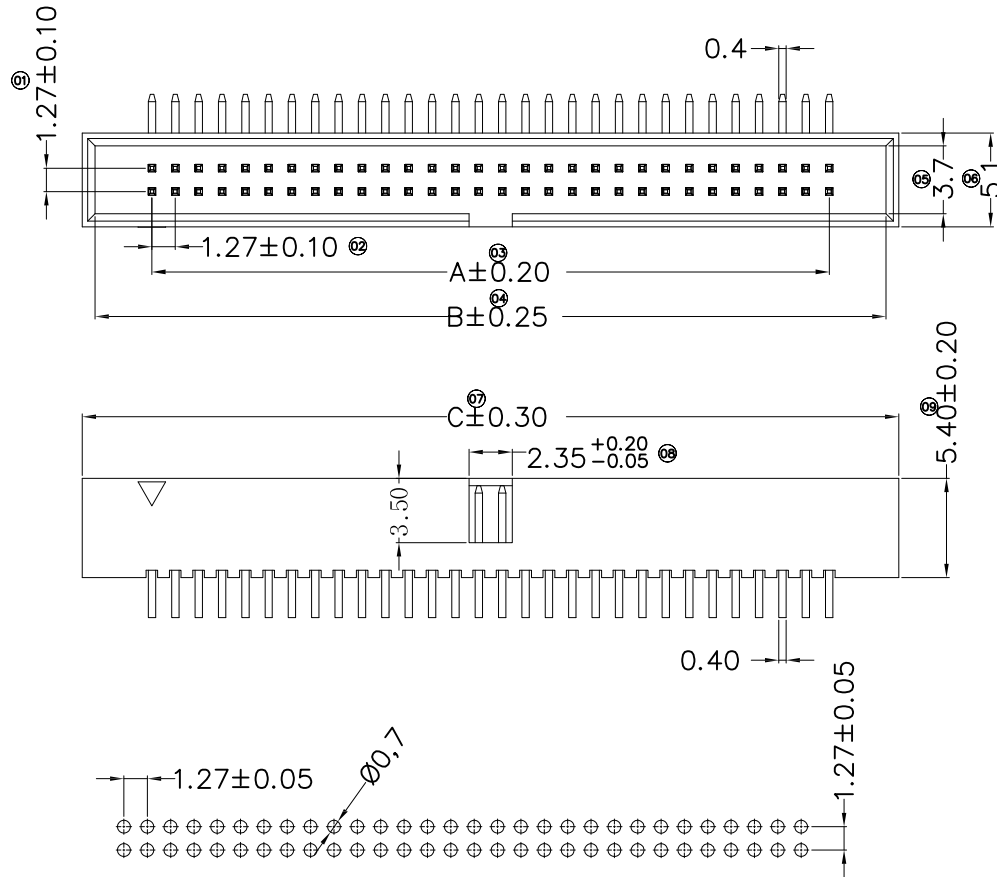

■ Specifications

- Voltage rating: 250V AC / DC
- Current rating: 0.5A AC / DC
- Withstanding voltage: 500V AC/minute
- Temperature range: -25° ~ +85°
- Insulation resistance: ≥100MΩ
- Contact resistance: ≤30mΩ
- After environmental testing: ≤40mΩ

1276 K R X- 2*XX X-6T V01 XX
 ① ② ③④ ⑤ ⑥ ⑦ ⑧ ⑨

- ① Series No.
- ② Category : K-Cowfish Longhorn Connector
- ③ Welding Board Angle : V-180° ; R-90°
- ④ Welding Way: Blank-DIP ; S-SMT
- ⑤ Row No.-Pin No.: XX-Single Row ; 2*XX-Double Row
- ⑥ Plug the Pin & Special No. :
- ⑦ Material: 6T -PA6T 94V-0
- ⑧ Plating Category: G**-Gold Plated Contact
 V**- All Gold-Plated
 01-Gold Flash 02-2u" 03-3u"
 05-5u" 10-10u" 15-15u"
 SN-Bright Tin Plating (70-120u")
 SN1-Bright Tin Plating (120u" Min).
 0-No Plating Material
 SW- Fog Tin Plating
 HS-Hight temperature Tin
- ⑨ Color : Blank-Natural Color

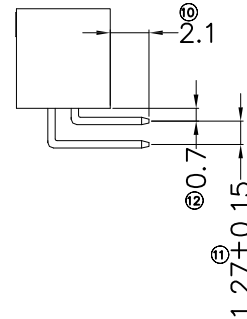

Recommended PCB Layout

1276KR-2*XX-6TV01 PA6T UL 94V-0 Brass	Gold-Flash	1276H	1,000Pcs
PART NO	Material	Material(Pin) Finish(Pin) Mates With SWB Housing	Qty./Bag

Poles	Dimensions (mm)			Poles	Dimensions (mm)		
	A	B	C		A	B	C
2*02	1.27	7.43	8.84	2*11	12.70	18.87	20.27
2*03	2.54	8.70	10.11	2*12	13.97	20.14	21.54
2*04	3.81	9.98	11.38	2*13	15.24	21.41	22.81
2*05	5.08	11.25	12.65	2*15	17.78	23.95	25.35
2*06	6.35	12.52	13.92	2*17	20.32	26.49	27.89
2*07	7.62	13.79	15.19	2*20	24.13	30.30	31.70
2*08	8.89	15.06	16.46	2*25	30.48	36.65	38.05
2*09	10.16	16.33	17.73	2*30	36.83	43.00	44.40
2*10	11.43	17.60	19.00				

					GENERAL TOLERANCE		GYA 东莞市国亚电子有限公司 Dong Guan Guo Ya Connectors co., Ltd.				PARTNO. 1276KR-2*XX-6TV01				
					.X	±0.30					TITLE 1.27 mm Crimp Style Connector				
					.XX	±0.20					UNIT SCALE SHEET REV NUMBER				
					.XXX	±0.10					mm 1:1 1/1 A0 A-106				
					X.*	±2°	APPROVAL				CHECK				
					PROJECT		DRAWN				DATE				
DATE	REV	ECN NO	DESCRIPTION	MODIFY	APPROVAL	PROJECT		DRAWN				DATE			
1						PROJECT		DRAWN				DATE			

APPROVAL		CHECK		DRAWN		DATE	
Yangzhengguo		Yangzhengyi		Lviansheng		2016/08/26	