

RoHS

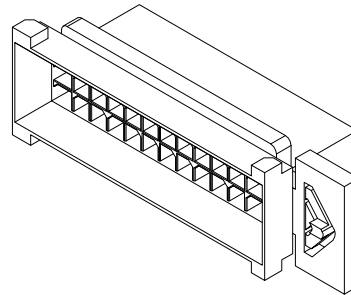
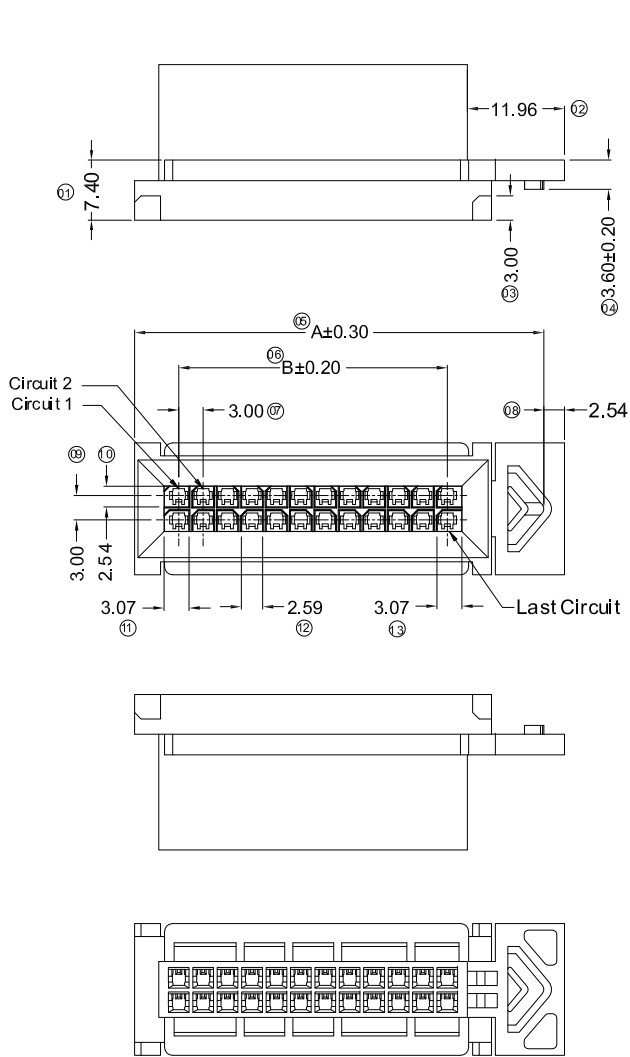

Specifications :

- Voltage rating: 250V AC / DC
- Current rating: 5A Max AC / DC
- Withstanding voltage: 1000V AC/minute
- Temperature range: -25°C~+ 85°C
- Insulation resistance: ≥1000MΩ
- Contact resistance: ≤10mΩ
- After environmental testing: ≤20mΩ
- Suitable GYA Terminal: A3000TM
- Female With GYA Mate HSG: A3000HM

A3000 H F - 2xXX - N0 B B R 01 F

① ② ③ ④ ⑤ ⑥ ⑦ ⑧ ⑨ ⑩

- ① Series No.
- ② Category: H-HSG
- ③ Connector Type: F-Female HSG
- ④ Row No.-Pin No.: 2xXX-Double Row
- ⑤ Material: N0-PA66 94V-0
- ⑥ Color: B- Black
- ⑦ Packing: B-Bag
- ⑧ RoHS/HF: R-Rohs
- ⑨ Sequence Number: 01
- ⑩ Special code: F-Other Connectors

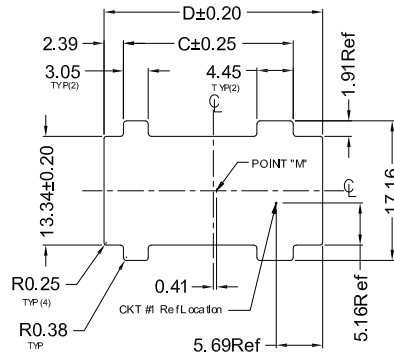

When mating with A3000HF series, Point "M" must align with the panel cut-out centerlines defined by GYA drawing A3000HF-2xXX-N0BBR01F

Poles	Dimensions(mm)				Poles	Dimensions(mm)			
	A	B	C	D		A	B	C	D
2*01					2*07	35.3	18.00	29.85	35.85
2*02	20.3	3.00	14.85	20.85	2*08	38.3	21.00	32.85	38.85
2*03	23.3	6.00	17.85	23.85	2*09	41.3	24.00	35.85	41.85
2*04	26.3	9.00	20.85	26.85	2*10	44.3	27.00	38.85	44.85
2*05	29.3	12.00	23.85	29.85	2*11	47.3	30.00	41.85	47.85
2*06	32.3	15.00	26.85	32.85	2*12	50.3	33.00	44.85	50.85

GENERAL TOLERANCE

- .X ±0.30
- .XX ±0.20
- .XXX ±0.10
- X° ±2°

**GYA** 东莞市国亚电子有限公司  
Connectors DONGGUO GUOYAELECTRONICS CO.,LTD

APPROVAL CHECK DRAWN DATE

PROJECT PROJECT APPROVAL PROJECT APPROVAL PROJECT APPROVAL PROJECT APPROVAL

Yangzhengguo Yangjinyi Lvtiansheng 2018/09/06

PART NO.

A3000HF-2xXX-N0BBR01F

TITLE

MICRO FIT 3.0mm DUAL ROW FEMALE HOUSING

UNIT SCALE SHEET REV NUMBER

mm 1:1 1/2 A0 A-000

DATE	REV	ECN NO.	DESCRIPTION	MODIFY	APPROVAL
1					
2					
3					
4					

RoHS

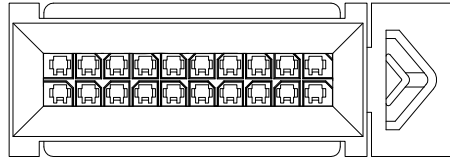

2x10

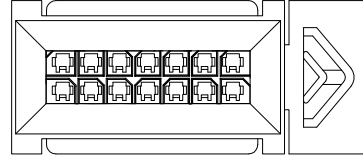

2x7

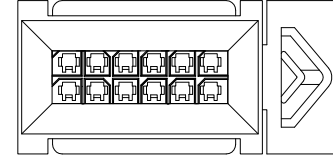

2x6

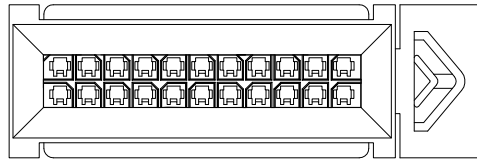

2x11

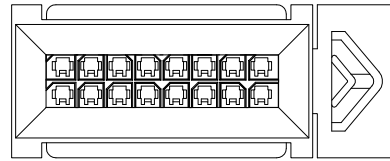

2x8

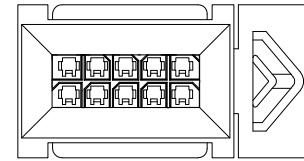

2x5

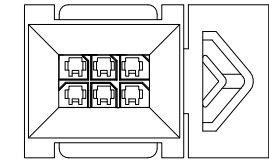

2x3

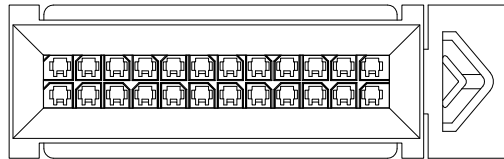

2x12

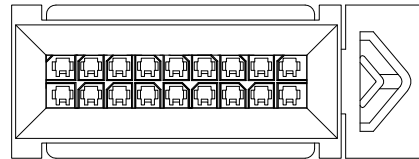

2x9

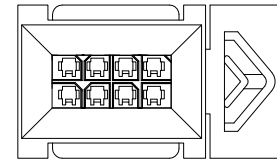

2x4

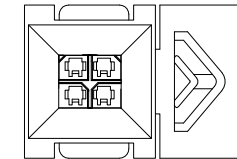

2x2

					GENERAL TOLERANCE .X ±0.30 .XX ±0.20 .XXX ±0.10 X:° ±2°				<b>GYA</b> 东莞市国亚电子有限公司 Connectors DONGGUO GUOYA ELECTRONICS CO.,LTD				PART NO. A3000HF 2 xXX-N 0BBR 01F							
					PROJECT 				APPROVAL Yangzhengguo		CHECK Yangjinyi		DRAWN Lvtiansheng		DATE 2018/09/06		TITLE MICRO FIT 3.0mm DUAL ROW FEMALE HOUSING			
DATE	REV	ECN NO.	DESCRIPTION	MODIFY	APPROVAL			UNIT	SCALE	SHEET	REV	NUMBER								
								mm	1:1	2/2	A0	A000								

RoHS

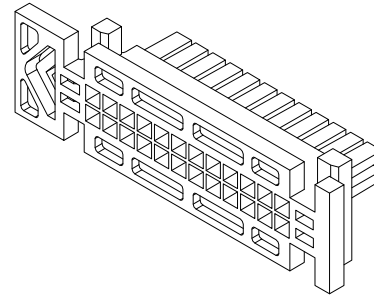
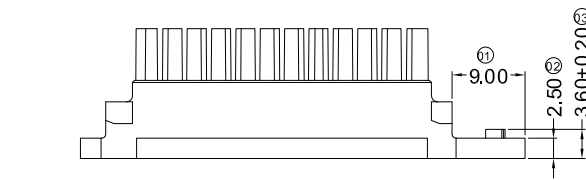

Specifications :

- Voltage rating: 250V AC / DC
- Current rating: 5A Max AC / DC
- Withstanding voltage: 1000V AC/minute
- Temperature range: -25°C~+85°C
- Insulation resistance: ≥1000MΩ
- Contact resistance: ≤10mΩ
- After environmental testing: ≤20mΩ
- Suitable GYA Terminal: A3000 TF
- Mate With GYA Female HSG : A3000HF

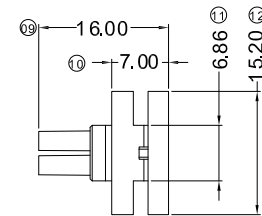
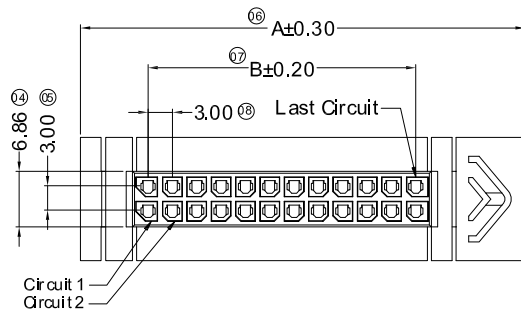

A3000 H M - 2xXX - N0 B B R 01 F  
 ① ② ③ ④ ⑤ ⑥ ⑦ ⑧ ⑨ ⑩

- ① Series No.
- ② Category: H-HSG
- ③ Connector Type: M-Male HSG
- ④ Row No.-Pin No.: 2xXX-Double Row
- ⑤ Material: N0-PA66 94V-0
- ⑥ Color: B-Black
- ⑦ Packing: B-Bag
- ⑧ RoHS/HF: R-Rohs
- ⑨ Sequence Number: 01
- ⑩ Special code: F-Other Connectors

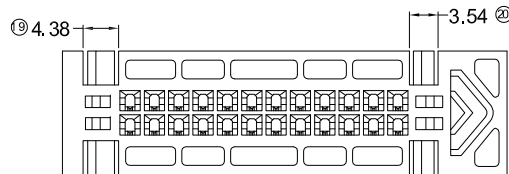
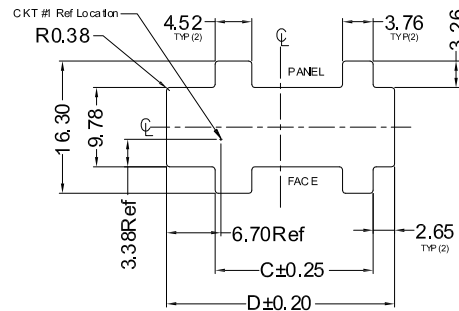
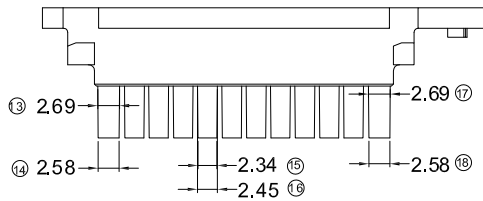

Poles	Dimensions(mm)				Poles	Dimensions(mm)			
	A	B	C	D		A	B	C	D
2*01					2*07	39.8	18.00	28.46	37.10
2*02	24.6	3.00	13.46	22.10	2*08	42.8	21.00	31.46	40.10
2*03	27.7	6.00	16.46	25.10	2*09	45.8	24.00	34.46	43.10
2*04	30.7	9.00	19.46	28.10	2*10	48.8	27.00	37.46	46.10
2*05	33.8	12.00	22.46	31.10	2*11	51.8	30.00	40.46	49.10
2*06	36.8	15.00	25.46	34.10	2*12	54.8	33.00	43.46	52.10

GENERAL TOLERANCE	
.X	±0.30
.XX	±0.20
.XXX	±0.10
X°	±2°
PROJECT	

**GYA** 东莞市国亚电子有限公司  
 Connectors DONGGUO GUOYA ELECTRONICS CO.,LTD

PART NO.  
 A3000HM-2xXX-N0BBR01F

APPROVAL	CHECK	DRAWN	DATE
Yangzhengguo	Yangjinyi	Lvtiansheng	2019/07/15

TITLE  
 MICRO FIT 3.0mm DUAL ROW PLUG HOUSING

DATE	REV	ECN NO.	DESCRIPTION	MODIFY	APPROVAL

UNIT	SCALE	SHEET	REV	NUMBER
mm	1:1	1/2	A0	A-000

RoHS

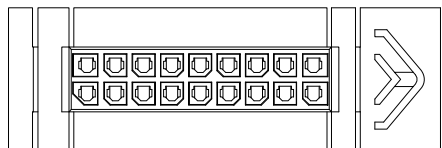

2x9

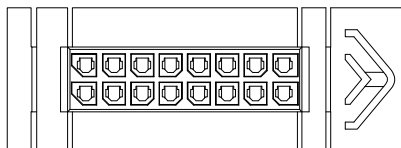

2x8

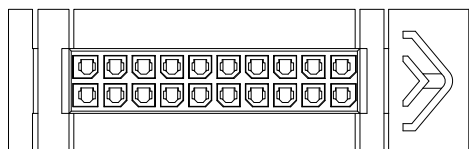

2x10

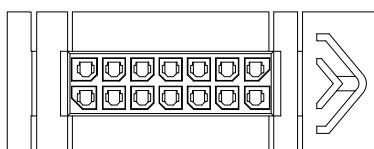

2x7

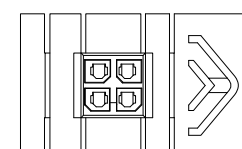

2x2

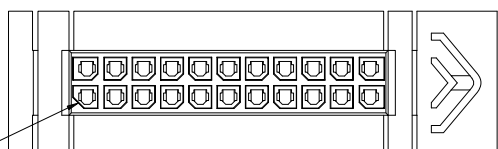

2x11

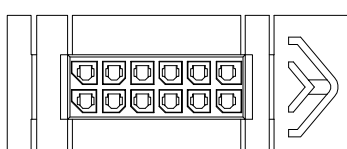

2x6

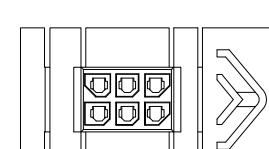

2x3

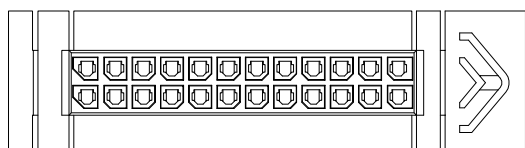

2x12

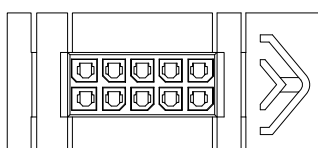

2x5

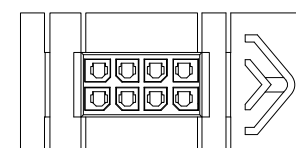

2x4

GENERAL TOLERANCE	
X	±0.30
.XX	±0.20
.XXX	±0.10
X°	±2°

**GYA** 东莞市国亚电子有限公司  
Connectors DONGGUO GUOYA ELECTRONICS CO.,LTD

PART NO.  
A3000HM-2xXX-NOBBR01F

TITLE  
MICRO FT 3.0mm DUAL ROW  
PLUG HOUSING

APPROVAL	CHECK	DRAWN	DATE
Yangzhengguo	Yangjiyini	Lvtiansheng	2019/07/15

UNIT	SCALE	SHEET	REV	NUMBER
mm	1:1	2/2	A0	A-000

DATE	REV	ECN NO.	DESCRIPTION	MODIFY	APPROVAL
1					



RoHS

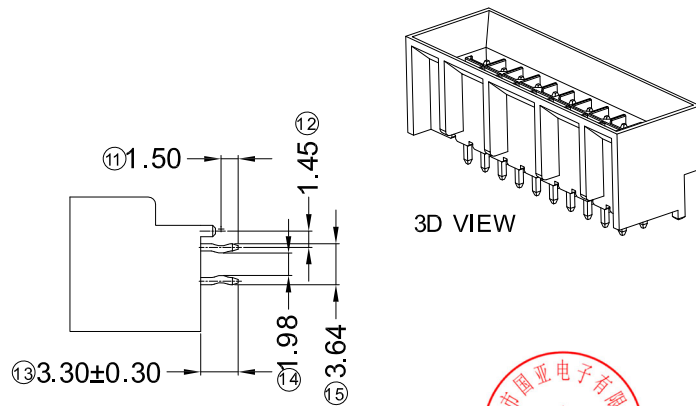
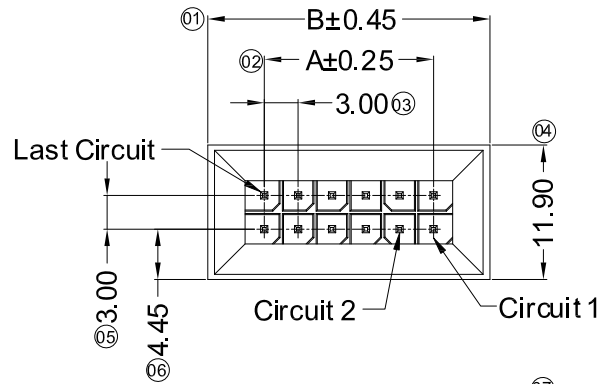

3D VIEW

■ Specifications :

- Voltage rating: 250V AC / DC
- Current rating: 5A AC / DC
- Withstanding voltage: 1000V AC/minute
- Temperature range: -25°C~+85°C
- Insulation resistance: ≥1000MΩ
- Contact resistance: ≤20mΩ
- After environmental testing: ≤30mΩ
- Material(Pin): Brass
- Mates With GYA Housing A3000H

A3000 W V X- 2\*XX P - 9T XX XX  
 ① ②③④ ⑤ ⑥ ⑦ ⑧ ⑨

- ① Series No.
- ② Category: W-wafer
- ③ Connector Type: V-180°
- ④ Mounting Type: Blank-DIP
- ⑤ Row No.-Pin No.: 2\*XX-Double row
- ⑥ Special NQ: P-With Post
- ⑦ Material: 9T-PA9T 94V-0
- ⑧ Plating Category:  
 SW1-Matte Tin 100u" Min; Ni 50u" Min.  
 V01- Au Gold Flash ; Ni 50u" Min.
- ⑨ Color: Blank- Black Color

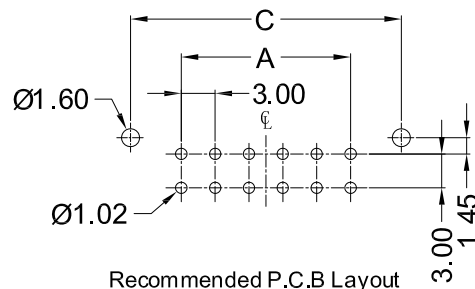
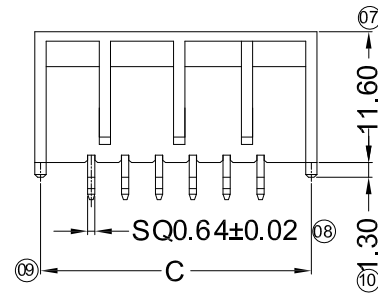

Recommended P.C.B Layout  
 General Tolerance±0.05

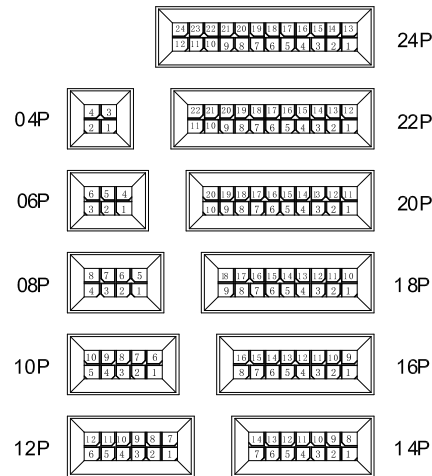

Part No.	Dimensions (mm)		
	A	B	C
2x02	3.00	13.00	12.00
2x03	6.00	16.00	15.00
2x04	9.00	19.00	18.00
2x05	12.00	22.00	21.00
2x06	15.00	25.00	24.00
2x07	18.00	28.00	27.00
2x08	21.00	31.00	30.00
2x09	24.00	34.00	33.00
2x10	27.00	37.00	36.00
2x11	30.00	40.00	39.00
2x12	33.00	43.00	42.00

GENERAL TOLERANCE					APPROVAL				PART NO. A3000WV-2*XXP-9TXXXX					
.X ±0.30					<b>GYA</b> 东莞市国亚电子有限公司 Connectors DONGGUO GUOYA ELECTRONICS CO.,LTD				TITLE 3.00mm Crimp Style Connectors					
.XX ±0.20														
.XXX ±0.10					CHECK DRAWN DATE Yangjinyi Lvtiansheng 2019/11/02				UNIT SCALE SHEET REV NUMBER mm 1:1 1/1 A0 A-007					
X° ±2°					PROJECT									
DATE	REV	ECN NO.	DESCRIPTION	MODIFY	APPROVAL									

RoHS

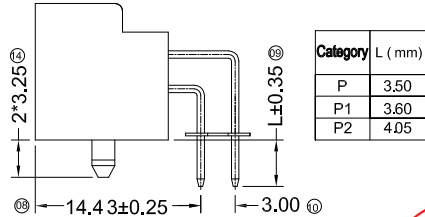
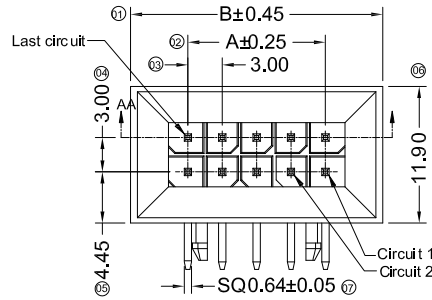

Category	L (mm)
P	3.50
P1	3.60
P2	4.05

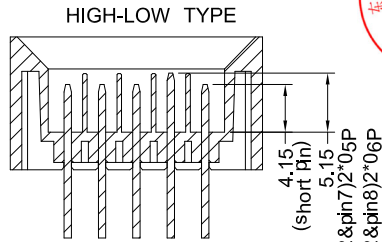
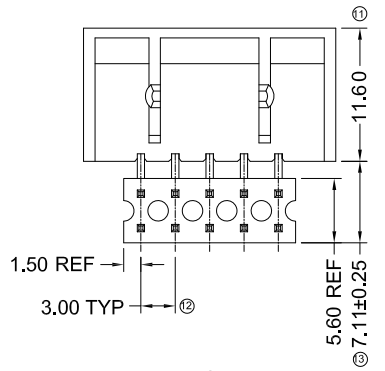

SECTION A-A  
SCALE:1:1

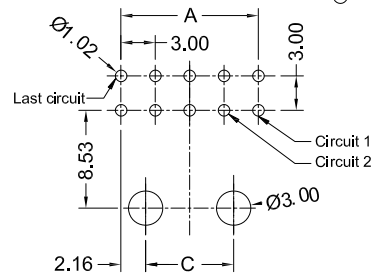

Recommended P.C.B Layout  
General Tolerance±0.05

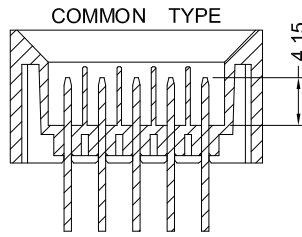

SECTION A-A  
SCALE:1:1

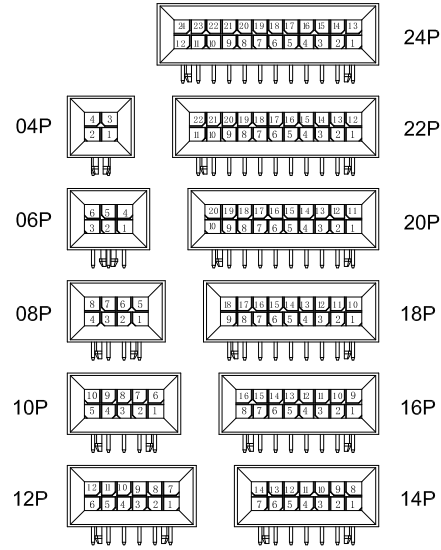

CIRCUIT SIZE LAYOUT

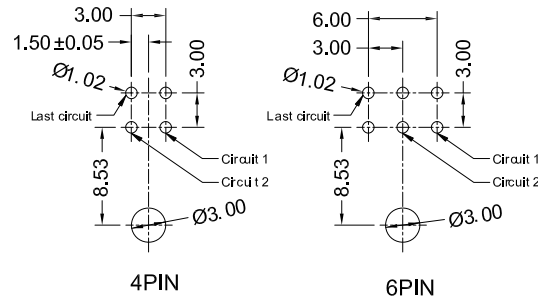

Recommended P.C.B Layout  
General Tolerance±0.05

Specifications :

- Voltage rating: 250V AC / DC
- Current rating: 5A AC / DC
- Withstanding voltage: 1000V AC/minute
- Temperature range: -25°C~+85°C
- Insulation resistance: ≥1000MΩ
- Contact resistance: ≤10mΩ
- After environmental testing: ≤20mΩ
- Material(Pin):Brass
- Mates With GYA Housing:A3000HM

- A3000 W R X-2\*XX X PX-XX XX XX T
- ① Series No.  
② Category: W-Wafer  
③ Connector Type: R-90°  
④ Mounting Type: Blank-DIP  
⑤ Row No.-Pin No Per Row: 2\*XX-2\*02P~2\*12P  
⑥ Special No. : Blank-COMMON PIN D-HIGH-LOW PIN  
⑦ P-A positioning column; DIP=3.50mm  
P1-A positioning column;DIP=3.60mm  
P2-A positioning column;DIP=4.05mm  
⑧ Material: 9T-PA9T 94V-0 (Halogen Free)  
LP-LCP 94V-0  
⑨ Plating Code: SN-Bright Tin SW-Matte Tin  
⑩ Color: Blank-Black  
⑪ Packing: T-Tray

Poles	Dimensions (mm)		
	AB		C
2*02	3.00	13.00	
2*03	6.00	16.00	
2*04	9.00	19.00	4.68
2*05	12.00	22.00	7.68
2*06	15.00	25.00	10.68
2*07	18.00	28.00	13.68
2*08	21.00	31.00	16.68
2*09	24.00	34.00	19.68
2*10	27.00	37.00	22.68
2*11	30.00	40.00	25.68
2*12	33.00	43.00	28.68

GENERAL TOLERANCE	
.X	±0.30
.XX	±0.20
.XXX	±0.10
X.°	±2°
PROJECT	
⊕	⊖

**GYA** 东莞市国亚电子有限公司  
Connectors DONGGUO GUOYU ELECTRONICS CO.,LTD

APPROVAL	CHECK	DRAWN	DATE
Yangzhengguo	Yangjinyi	Lvtiansheng	2020/05/11

PART NO.  
A3000WR-2\*XXXXP-XXXXT

TITLE  
3.00mm Crimp Style Connectors

UNIT	SCALE	SHEET	REV	NUMBER
mm	1:1	1/1	A0	A-007

DATE	REV	ECN NO.	DESCRIPTION	MODIFY	APPROVAL
1		2	3	4	5