

RoHS

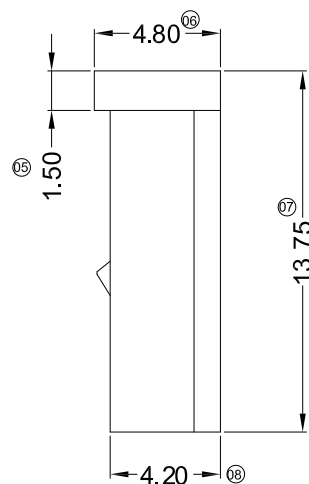
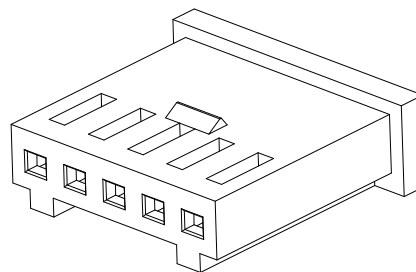
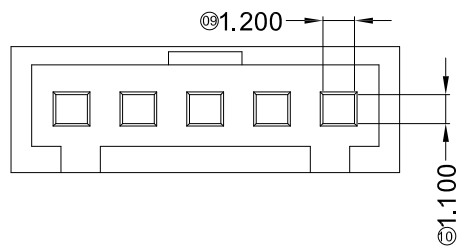
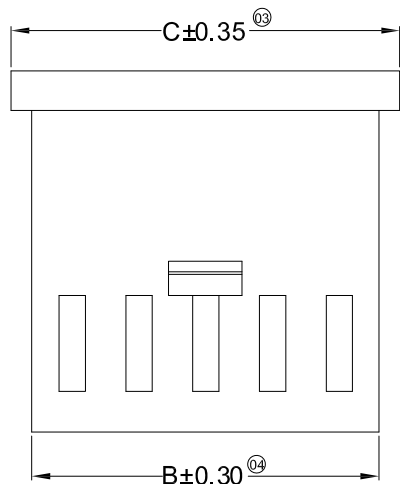
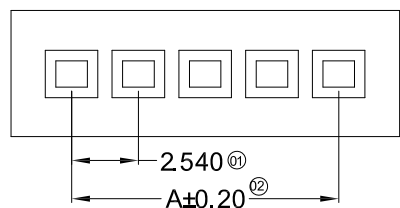

■ Specifications :

- Voltage rating: 250V AC / DC
- Current rating: 3A AC / DC
- Withstanding voltage: 800V AC/minute
- Temperature range: -25°C~+85°C
- Insulation resistance: ≥1000MΩ
- Contact resistance: ≤10mΩ
- After environmental testing: ≤20mΩ
- Suitable GYA Terminal: A2542T Mates
- With GYA Wafer: A2542W

A2542 H X-XX X-N0 XX

① ② ③ ④ ⑤ ⑥ ⑦

- ① Series No.
- ② Category: H-HSG
- ③ Connector Type: Blank-ordinary
- ④ Row No.-Pin No Per Row: XX-02~20P
- ⑤ Plug the Pin & special No.: Blank-ordinary
- ⑥ Material: N0-PA66 94V-0
- ⑦ Color: Blank-Natural

Pdes	Dimensions(mm)			Poles	Dimensions(mm)		
	A	B	C		A	B	C
02	2.54	5.60	7.10	13	30.48	33.54	35.04
03	5.08	8.14	9.64	14	33.02	36.08	37.58
04	7.62	10.68	12.18	15	35.56	38.62	40.12
05	10.16	13.22	14.72	16	38.10	41.16	42.66
06	12.70	15.76	17.26	17	40.64	43.70	45.20
07	15.24	18.30	19.80	18	43.18	46.24	47.74
08	17.78	20.84	22.34	19	45.72	48.78	50.28
09	20.32	23.38	24.88	20	48.26	51.32	52.82
10	22.86	25.92	27.42	21	50.80	53.86	55.36
11	25.40	28.46	29.96	22	53.34	56.40	57.90
12	27.94	31.00	32.50				

GENERAL TOLERANCE

- .X ±0.30
- .XX ±0.20
- .XXX ±0.10
- X° ±2°

GYA 东莞市国亚电子有限公司
Connectors DONGGUO GUOYAELECTRONICS CO.,LTD

PART NO.
A2542H-XX-N0

TITLE
2.54mm Crimp Style Connectors

APPROVAL	CHECK	DRAWN	DATE
Yangzhengguo	Yangjinyi	Lvtiansheng	2007/05/03

UNIT	SCALE	SHEET	REV	NUMBER
mm	1:1	1/1	A0	A-089

DATE	REV	ECN NO.	DESCRIPTION	MODIFY	APPROVAL



RoHS

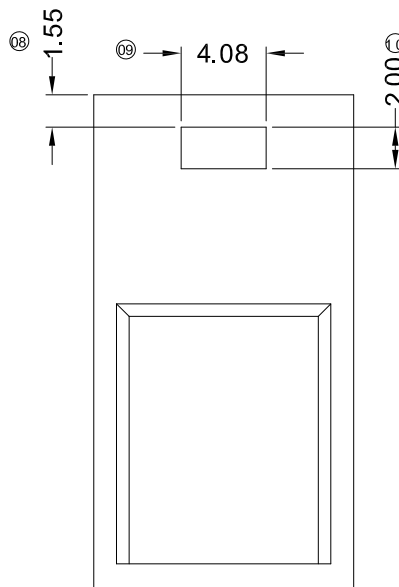
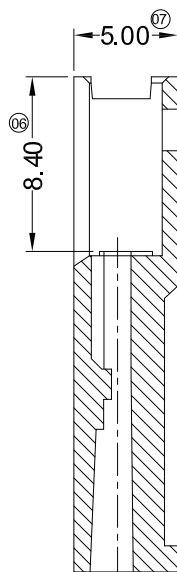
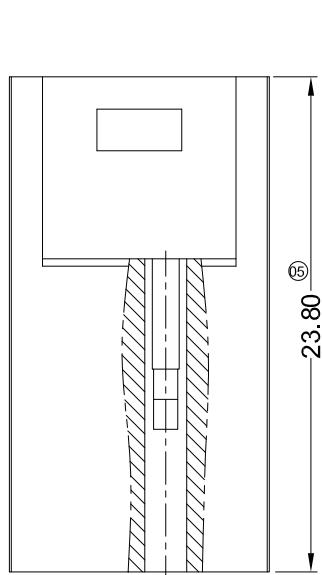
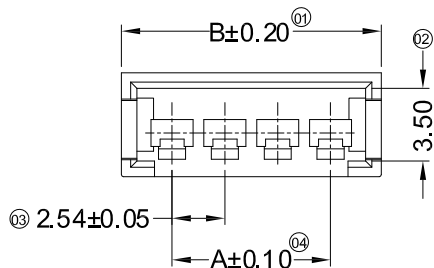

Specifications :

- Voltage rating: 250V AC / DC
- Current rating: 3A AC / DC
- Withstanding voltage: 800V AC/minute
- Temperature range: -25°C~+85°C
- Insulation resistance: ≥1000MΩ
- Contact resistance: ≤10mΩ
- After environmental testing: ≤20mΩ
- Suitable GYA Terminal: A2542TM
- Mates With GYA Housing: A2542H-XX

A2542 H F - XX X-PT XX

- ① Series No.
- ② Category: H-HSG
- ③ Connector Type: F-Female HSG
- ④ Row No. Pin No Per Row: 2*XX-2*02P~2*20P
- ⑤ Plug The Pin & Special No.: Blank-Ordinary
- ⑥ Material: PT-PBT 94V-0
- ⑦ Color: Blank-Natural

Poles	Dimension s(mm)		Poles	Dimensions(mm)	
	A	B		A	B
2	2.54	7.42	12	27.94	32.82
3	5.08	9.96	13	30.48	35.36
4	7.62	12.50	14	33.02	37.90
5	10.16	15.04	15	35.56	40.44
6	12.70	17.58	16	38.10	42.98
7	15.24	20.12	17	40.64	45.52
8	17.78	22.66	18	43.18	48.06
9	20.32	25.20	19	45.72	50.06
10	22.86	27.74	20	48.26	53.14
11	25.40	30.28			

GENERAL TOLERANCE

- .X ±0.30
- .XX ±0.20
- .XXX ±0.10
- X:° ±2°

PROJECT



东莞市国亚电子有限公司
DONGGUO GUOYAN ELECTRONICS CO.,LTD

PART NO.
A2542HF-XX-PT

TITLE
2.54 mm Crimp Style Connectors

APPROVAL	CHECK	DRAWN	DATE
Yangzhengguo	Yangjinyi	Lvtiansheng	2016/06/24

UNIT	SCALE	SHEET	REV	NUMBER
mm	1:1	1/1	A0	A-106

DATE	REV	ECN NO.	DESCRIPTION	MODIFY	APPROVAL
1					
2					
3					
4					

RoHS

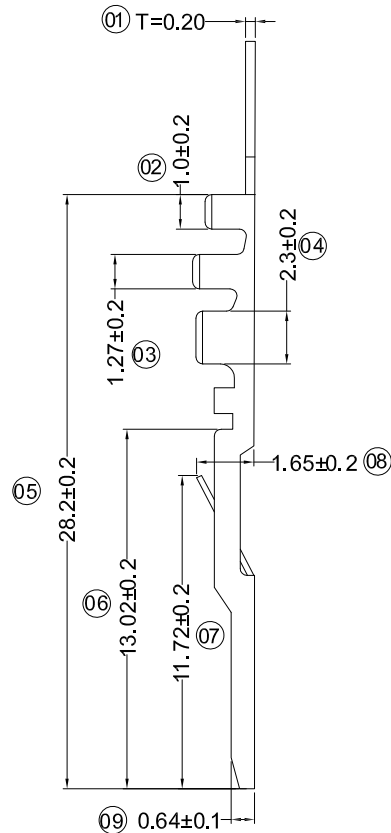
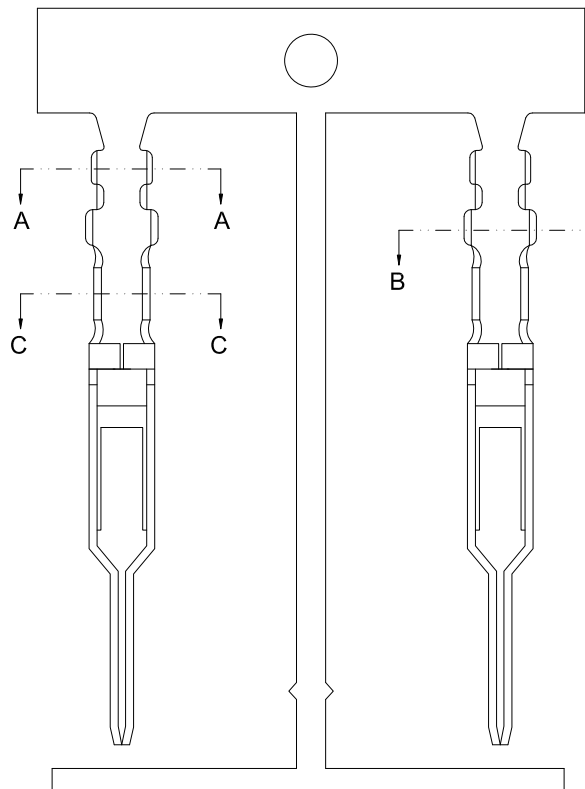

■ Specifications :

- Voltage rating: 250V AC / DC
- Current rating: 3A AC / DC
- Withstanding voltage: 800V AC/minute
- Temperature range: -25°C~+85°C
- Insulation resistance: ≥1000MΩ
- Contact resistance: ≤10mΩ
- After environmental testing: ≤20mΩ

- Wire Size: AWG #22~26
- Insulation O.D.:1.55mm (Max)
- Used In GYA Housing: A2542H

A2542 T M-X SN X-X

① ② ③ ④ ⑤ ⑥ ⑦

- ① Series Number
- ② Category: T-Terminal
- ③ Shape: M-Male
- ④ Material: P-Phosphor Bronze B-Brass
- ⑤ Plating Code: SN-Ni 30u" Min Bright tin 70u" Min
- ⑥ Plating Method: B-Plating Before Stamping
- ⑦ M d No./Mark/Special No. : Blank-Ordinary

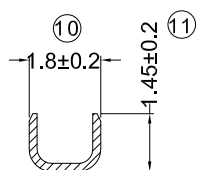

SECTION A-A
SCALE 1 : 1

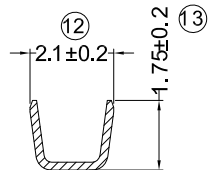

SECTION B-B
SCALE 1 : 1

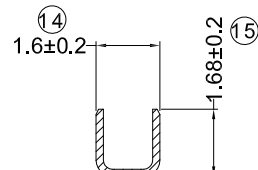

SECTION C-C
SCALE 1 : 1



GENERAL TOLERANCE

.X	±0.30
.XX	±0.20
.XXX	±0.10
X.°	±2°

GYA 东莞市国亚电子有限公司
Connectors DONGGUO GUOYAELECTRONICS CO.,LTD

PART NO.
A2542TM-XSN

TITLE
2.54 mm Crimp Style Connectors

APPROVAL	CHECK	DRAWN	DATE
Yangzhengguo	Yangjinyi	Lvliansheng	2007/05/03

UNIT	SCALE	SHEET	REV	NUMBER
mm	1 : 1	1/1	A0	A-093

DATE	REV	ECN NO.	DESCRIPTION	MODIFY	APPROVAL
1					

RoHS

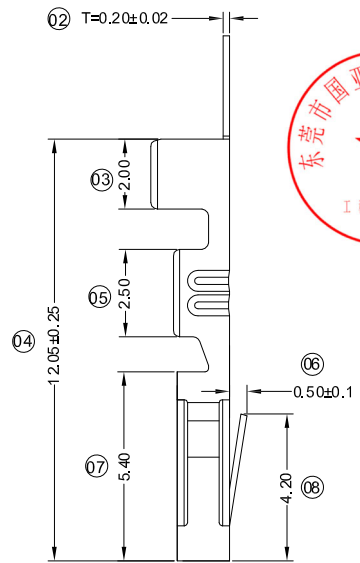
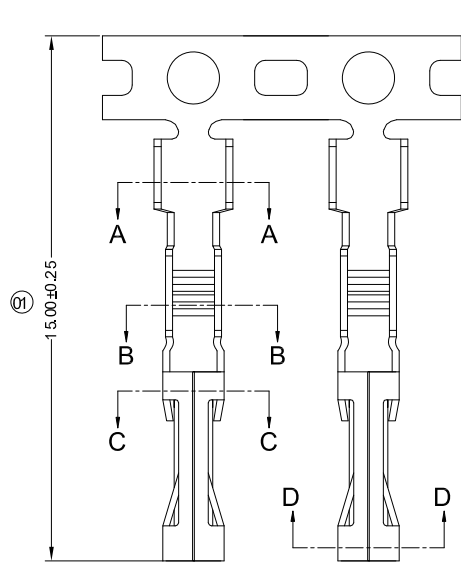

■ Specifications :

- Voltage rating: 250V AC / DC
- Current rating: 3A AC / DC
- Withstanding voltage: 800V AC/minute
- Temperature range: -25°C~+85°C
- Insulation resistance: ≥1000MΩ
- Contact resistance: ≤10mΩ
- After environmental testing: ≤20mΩ

- Wire Size: AWG #22~26
- Insulation O.D.: 1.55mm (Max)
- Used In GYA Housing: A2542H

A2542 T F-P SN X-A

① ② ③ ④ ⑤ ⑥ ⑦

- ① Series Number
- ② Category: T-Terminal
- ③ Shape: F-Female
- ④ Material: P-Phosphor Bronze
- ⑤ Plating Code: SN-Ni 30u" Min Bright tin 70u" Min
- ⑥ Plating Method: B-Plating Before Stamping
- ⑦ Mold No./Mark/Special No. : A-Single Strip

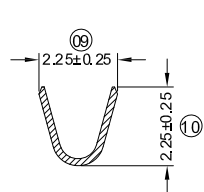

SECTION A-A
SCALE 1:1

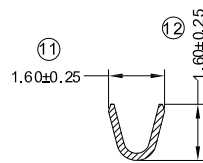

SECTION B-B
SCALE 1:1

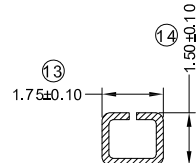

SECTION C-C
SCALE 1:1

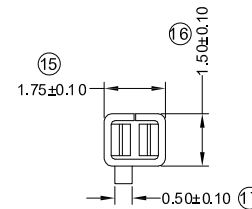

SECTION D-D
SCALE 1:1

GENERAL TOLERANCE

- .X ±0.30
- .XX ±0.20
- .XXX ±0.10
- X° ±2°



东莞市国亚电子有限公司
DONGGUO GUOYAELECTRONICS CO.,LTD

PART NO.
A2542TF-PSN-A

TITLE
2.54 mm Crimp Style Connectors

DATE	REV	ECN NO.	DESCRIPTION	MODIFY	APPROVAL

PROJECT	APPROVAL	CHECK	DRAWN	DATE
Yangzhengguo	Yangjinyi	Lvtiansheng	2007/05/03	

UNIT	SCALE	SHEET	REV	NUMBER
mm	1:1	1/1	A0	A-053

RoHS

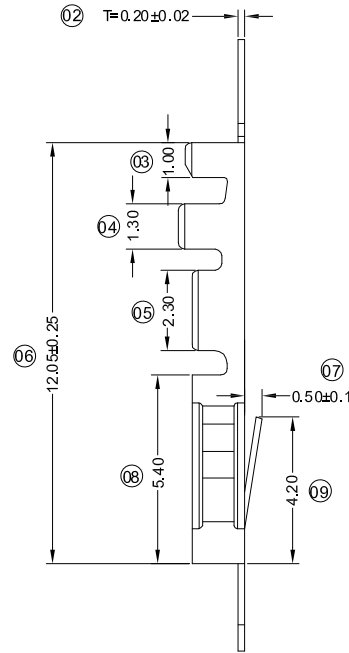
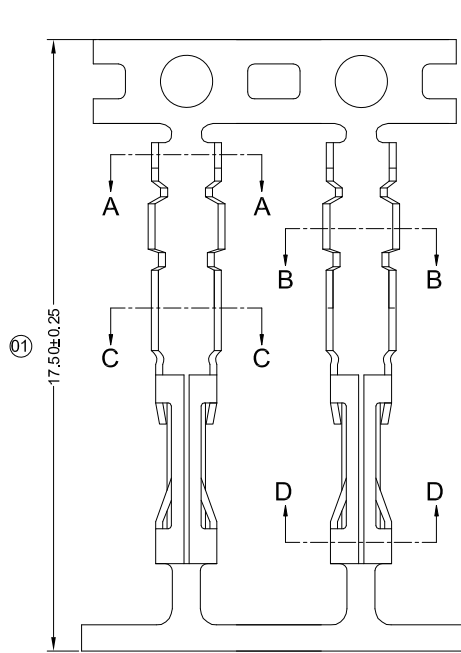

■ Specifications :

- Voltage rating: 250V AC / DC
- Current rating: 3A AC / DC
- Withstanding voltage: 800V AC/minute
- Temperature range: -25°C~+85°C
- Insulation resistance: ≥1000MΩ
- Contact resistance: ≤10mΩ
- After environmental testing: ≤20mΩ

- Wire Size: AWG #22~26
- Insulation O.D.: 1.55mm (Max)
- Used In GYA Housing: A2542H

A2542 T F-P SN X-X
① ② ③ ④ ⑤ ⑥ ⑦

- ① Series Number
- ② Category: T-Terminal
- ③ Shape: F-Female
- ④ Material: P-Phosphor Bronze
- ⑤ Plating Code: SN-Ni 30u" Min Bright tin 70u" Min
G10- Contact Area Gold 10u" Au
- ⑥ Plating Method: B-Plating Before Stamping
- ⑦ Mold No./Mark/Special No. : Blank-Ordinary

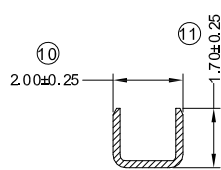

SECTION A-A
SCALE 1 : 1

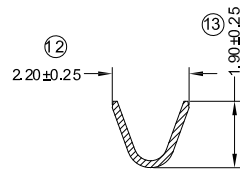

SECTION B-B
SCALE 1 : 1

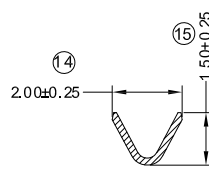

SECTION C-C
SCALE 1 : 1

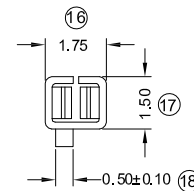

SECTION D-D
SCALE 1 : 1

					GENERAL TOLERANCE				PART NO.						
					.X ±0.30				A2542TF-PXXX						
					.XX ±0.20				TITLE						
					.XXX ±0.10				2.54 mm Crimp Style Connectors						
					X.° ±2°				APPROVAL	CHECK	DRAWN	DATE			
DATE	REV	ECN NO.	DESCRIPTION	MODIFY	APPROVAL	PROJECT	Yangzhengguo	Yangjinyi	Lvtiansheng	2007/05/03	UNIT	SCALE	SHEET	REV	NUMBER
1						⊕					mm	1 : 1	1/1	A0	A-053

GYA 东莞市国亚电子有限公司
Connector's DONGGUO GUOYAELECTRONICS CO.,LTD

APPROVAL: Yangzhengguo
CHECK: Yangjinyi
DRAWN: Lvtiansheng
DATE: 2007/05/03

RoHS

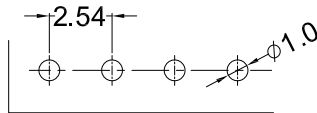
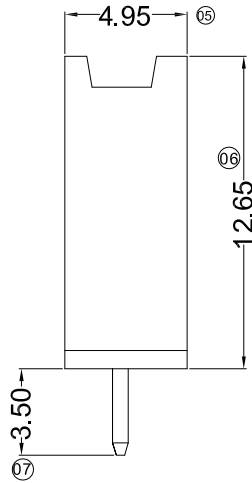
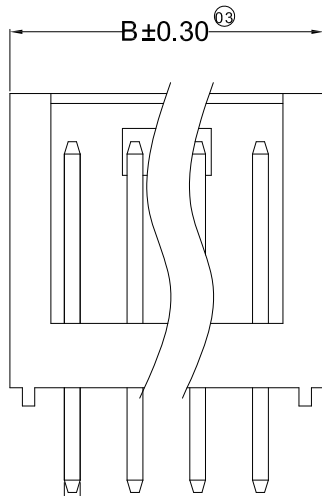
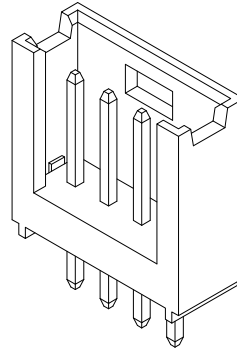
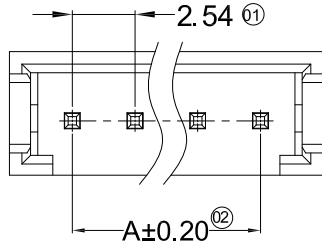

Recommended P.C.B Layout
General Tolerance ±0.05

■ Specifications :

- Voltage rating: 250V AC /DC
- Current rating: 3A AC /DC
- Withstanding voltage: 800V AC/minute
- Temperature range: -25°C~+85°C
- Insulation resistance: ≥1000MΩ
- Contact resistance: ≤10mΩ
- After environmental testing: ≤20mΩ
- Material(Pin): Brass
- Mates With GYA Housing: A2542 H

A2542 W V XX- XX X-PTS N XX

- ① ② ③ ④ ⑤ ⑥ ⑦ ⑧ ⑨
- ① Series No.
 - ② Category: W-Wafer
 - ③ Connector Type: V-Stright 180°
 - ④ Mounting Type: Blank-DIP
 - ⑤ Row No.-Pin No Per Row: XX-02~22P
 - ⑥ Special No.: Blank-Ordinary
 - ⑦ Material: PT-PBT 94V-0
 - ⑧ Plating Code: SN-Bright Tin
 - ⑨ Color: Blank-Black ; RE-Red ; WH-White

Poles	Dimensions(mm)		Poles	Dimensions(mm)	
	A	B		A	B
02	2.54	7.70	13	30.48	35.60
03	5.08	10.20	14	33.02	38.10
04	7.62	12.70	15	35.56	40.70
05	10.16	15.20	16	38.10	43.20
06	12.70	17.80	17	40.64	45.70
07	15.24	20.30	18	43.18	48.20
08	17.78	22.90	19	45.72	50.70
09	20.32	25.40	20	48.26	53.20
10	22.86	28.00	22	53.34	58.50
11	25.40	30.50			
12	27.94	33.10			



					GENERAL TOLERANCE .X ±0.30 .XX ±0.20 .XXX ±0.10 X° ±2°				GYA 东莞市国亚电子有限公司 Connectors DONGGUO GUOYAELECTRONICS CO.,LTD				PART NO. A2542WV-XX-PTS NXX			
					PROJECT 				APPROVAL Yangzhengguo				CHECK Yangjinyi			
					DRAWN Lviansheng				DATE 2017/03/17				TITLE 2.54mm Crimp Style Connectors			
DATE	REV	ECN NO.	DESCRIPTION	MODIFY	APPROVAL			UNIT	SCALE	SHEET	REV	NUMBER				
1								mm	1:1	1:1	A0	A-00				

RoHS

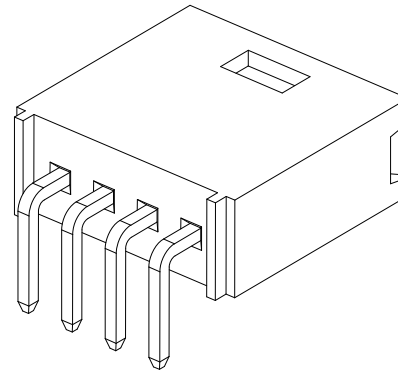
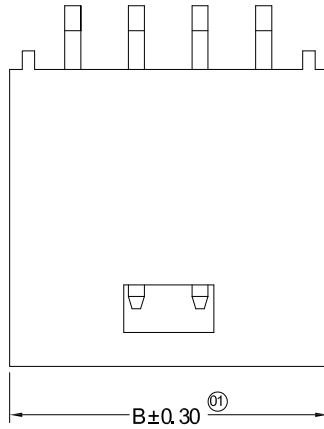

■ Specifications :

- Voltage rating: 250V AC / DC
- Current rating: 3A AC / DC
- Withstanding voltage: 800V AC/minute
- Temperature range: -25°C~+85°C
- Insulation resistance: ≥1000MΩ
- Contact resistance: ≤10mΩ
- After environmental testing: ≤20mΩ
- Material(Pin): Brass
- Mates With GYA Housing: A2542H

A2542 WR XX- XX X-P TSN XX

① ②③④ ⑤ ⑥⑦⑧ ⑨

- ① Series No.
- ② Category: W-Wafer
- ③ Connector Type: R-Right Angle 90°
- ④ Mounting Type: Blank-DIP
- ⑤ Row No.-Pin No Per Row: XX-02-22P
- ⑥ Special No.: Blank-Ordinary
- ⑦ Material: PT-PBT 94V-0
- ⑧ Plating Code: SN-Bright Tin
- ⑨ Color: Blank-Black ; RE-Red ; WH-White

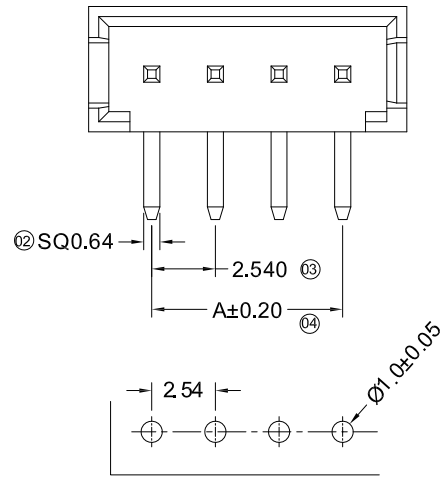

Recommended P.C.B Layout
General Tolerance±0.05

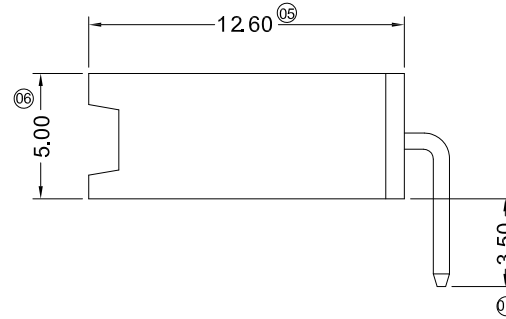

Poles	Dimensions(mm)		Poles	Dimensions(mm)	
	A	B		A	B
02	2.54	7.70	12	27.94	33.10
03	5.08	10.20	13	30.48	35.60
04	7.62	12.70	14	33.02	38.10
05	10.16	15.20	15	35.56	40.70
06	12.70	17.80	16	38.10	43.20
07	15.24	20.30	17	40.64	45.70
08	17.78	22.90	18	43.18	48.20
09	20.32	25.40	19	45.72	50.70
10	22.86	28.00	20	48.26	53.20
11	25.40	30.50	22	53.34	58.50

GENERAL TOLERANCE

.X ±0.30

.XX ±0.20

.XXX±0.10

X° ±2°

PROJECT

PROJECT



东莞市国亚电子有限公司
DONGGUO GUOYU ELECTRONICS CO.,LTD

APPROVAL

CHECK

DRAWN

DATE

Yangzhengguo

Yangjinyi

Lvtiansheng

2007/05/03

PART NO.

A2542WR-XX-P TSNXX

TITLE

2.54mm Crimp Style Connectors

UNIT

SCALE

SHEET

REV

NUMBER

mm

1:1

1/1

A0

A-089

DATE	REV	ECN NO.	DESCRIPTION	MODIFY	APPROVAL	PROJECT	APPROVAL	CHECK	DRAWN	DATE	UNIT	SCALE	SHEET	REV	NUMBER
						PROJECT					mm	1:1	1/1	A0	A-089