

RoHS

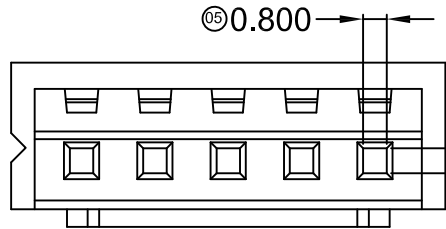
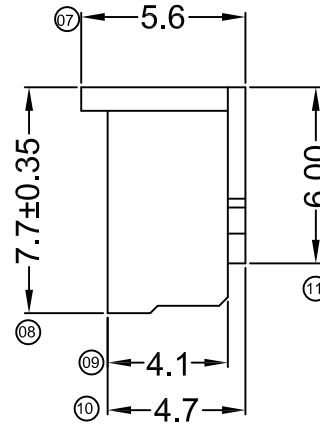
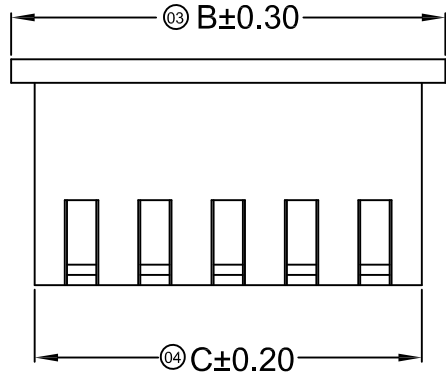
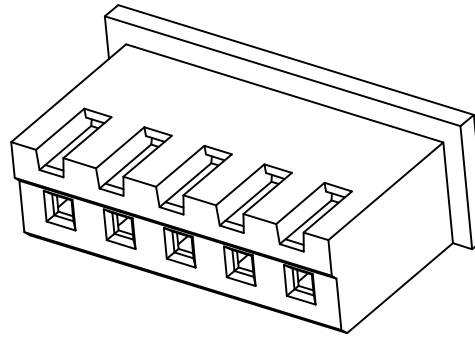
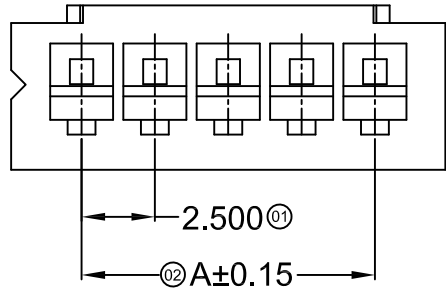

■ Specifications :

- Voltage rating: 250V AC / DC
- Current rating: 3A AC / DC
- Withstanding voltage: 1000V AC/minute
- Temperature range: -25°C~+85°C
- Insulation resistance: ≥1000MΩ
- Contact resistance: ≤10mΩ
- After environmental testing: ≤20mΩ
- Suitable GYA Terminal: A2508T
- Mates With GYA Wafer: A2508W

A2508 H X-XX X-N0 XX

① ② ③ ④ ⑤ ⑥ ⑦

- ① Series No.
- ② Category: H-HSG
- ③ Appearance type: Blank-Ordinary
- ④ Row No.-Pin No.: XX-Single Row
- ⑤ Special No. Blank-Ordinary
- ⑥ Material : N0-PA66 94V-0
- ⑦ Color: Blank : Natural Color



Poles	Dimensions(mm)			Poles	Dimensions(mm)		
	AB		C		AB		C
02	2.50	7.30	5.70	10	22.50	27.30	25.70
03	5.00	9.80	8.20	11	25.00	29.80	28.20
04	7.50	12.30	10.70	12	27.50	32.30	30.70
05	10.00	14.80	13.20	13	30.00	34.80	33.20
06	12.50	17.30	15.70	14	32.50	37.30	35.70
07	15.00	19.80	18.20	15	35.00	39.80	38.20
08	17.50	22.30	20.70	16	37.50	42.30	40.70
09	20.00	24.80	23.20				

GENERAL TOLERANCE

.X ±0.30

.XX ±0.20

.XXX ±0.10

X° ±2°

PROJECT



东莞市国亚电子有限公司
Dong Guan Guo Ya Connectors co., Ltd.

PART NO.

A2508H-XX-N0

TITLE

2.50mm Crimp style Connector

APPROVAL

CHECK

DRAWN

DATE

Yangzhengguo

Yangjinyi

Lvtiansheng

2015/07/25

UNIT

SCALE

SHEET

REV

NUMBER

mm

1:1

1/1

A

A-039

DATE	REV	ECN NO	DESCRIPTION	MODIFY	APPROVAL

RoHS

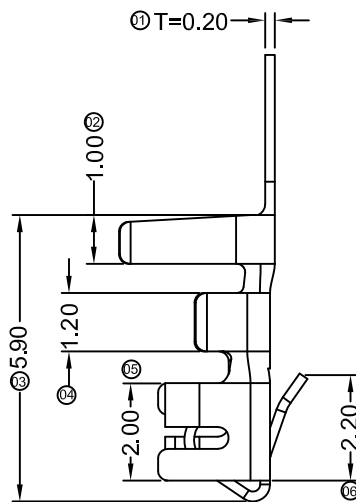
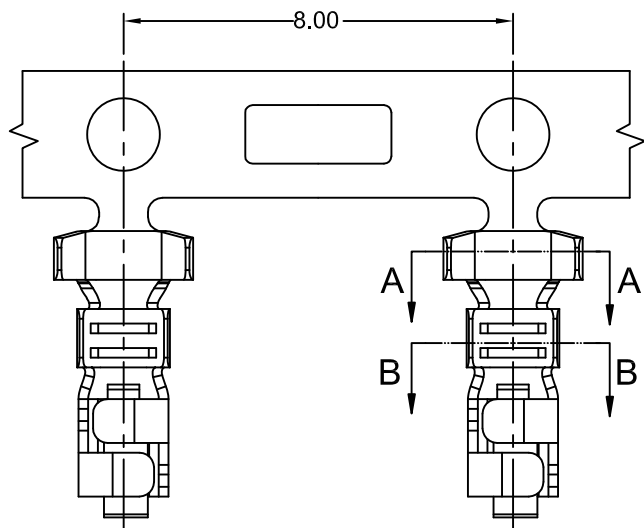

■ Specifications :

- Voltage rating: 250V AC / DC
- Current rating: 3A AC / DC
- Withstanding voltage: 1000V AC/minute
- Temperature range: -25°C~+85°C
- Insulation resistance: ≥1 000MΩ
- Contact resistance: ≤10mΩ
- After environmental testing: ≤20mΩ
- Wire Range: AWG#22-26
- Insulation O.D.: 1.90mm(Max)
- Used In GYA Housing: A2508H

A2508 T X-B SN X- X
① ② ③ ④ ⑤ ⑥ ⑦

- ① Series Number
- ② Category: T-terminal
- ③ Shape: Blank-ordinary
- ④ Material: B-Brass P-Phosphor bronze
- ⑤ Plating style: SN-Bright tin plating
- ⑥ Plating method:
Blank-Stamping before plating
- ⑦ Mold No./Mark/Special No.

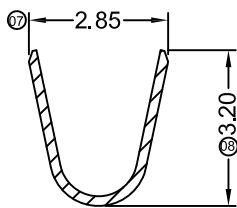

SECTION: A-A
SCALE: 1:1

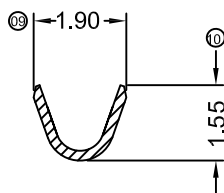

SECTION: B-B
SCALE: 1:1

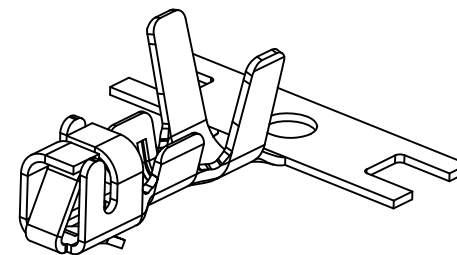
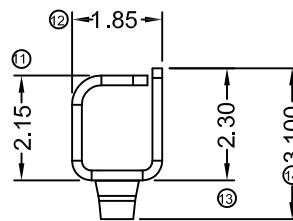

GENERAL TOLERANCE

.X ±0.30

.XX ±0.20

.XXX ±0.10

X° ±2°

PROJECT



东莞市国亚电子有限公司
Dong Guan Guo Ya Connectors co., Ltd.

PART NO.
A2508T-XSN

TITLE
2.50mm Crimp Style Connectors

APPROVAL CHECK DRAWN DATE

Yangzhengguo Yangjinyi Lvtiansheng 2014/06/23

UNIT	SCALE	SHEET	REV	NUMBER
mm	1:1	1/1	A	A-039

DATE	REV	ECN NO	DESCRIPTION	MODIFY	APPROVAL
1		2		4	

RoHS

Specifications :

- Voltage rating: 250V AC / DC
- Current rating: 3A AC / DC
- Withstanding voltage: 1000V AC/minute
- Temperature range: -25°C~+85°C
- Insulation resistance: ≥1000MΩ
- Contact resistance: ≤10mΩ
- After environmental testing: ≤20mΩ

A2508 W V X-XX H2 -N0 XX XX
 ① ② ③ ④ ⑤ ⑥ ⑦ ⑧ ⑨

- ① Series No.
- ② Category: W-WAFER
- ③ Welding Board Angle: V-180° ; R-90°
- ④ Welding Way: Blank-DIP ; S-SMT
- ⑤ Row No.-Pin No.: XX-Single Row ; 2*XX-D Double Row
- ⑥ Plug the Pin & Special No.: H2-Double-Faced Wafer
- ⑦ Material: N0 -PA66 94V-0
- ⑧ Plating Category: SN-Bright Tin Plating (70u")
- ⑨ Color : Blank-Natural Color ;



Poles	Dimensions (mm)		Poles	Dimensions (mm)	
	AB			AB	
02	2.50	7.50	11	25.00	30.00
03	5.00	10.00	12	27.50	32.50
04	7.50	12.50	13	30.00	35.00
05	10.00	15.00	14	32.50	37.50
06	12.50	17.50	15	35.00	40.00
07	15.00	20.00	16	37.50	42.50
08	17.50	22.50	17	40.00	45.00
09	20.00	25.00	18	42.50	47.50
10	22.50	27.50	19	45.00	50.00
11	25.00	30.00	20	47.50	52.50

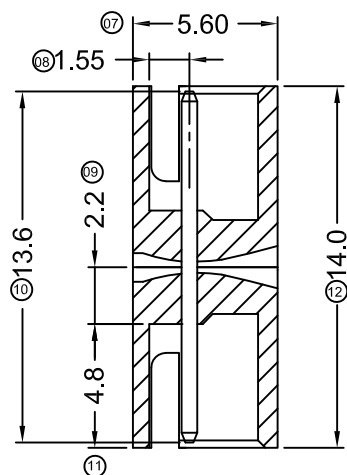
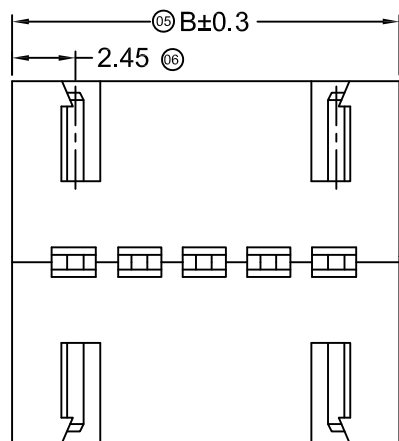
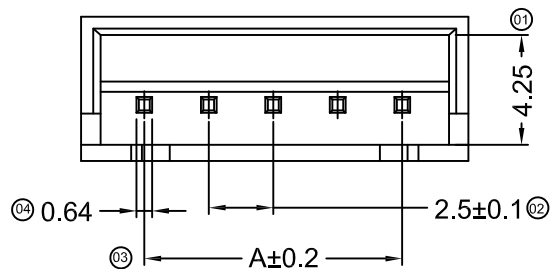
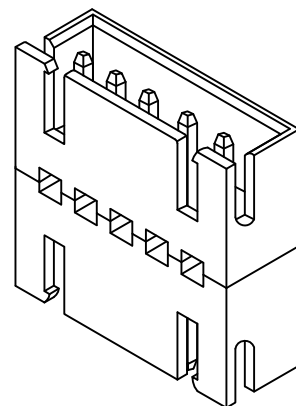

A2508WV-XXH2-N0SN	Nylon 66 UL 94V-0	Brass	Tin-Plated	A2508H
PART NO	Material	Material(Pin)	Finish(Pin)	Mates With GYA Housing

GENERAL TOLERANCE					PART NO.						
.X ±0.30					A2508WV-XXH2-N0SN						
.XX ±0.20					TITLE						
.XXX ±0.10					2.50 mm Crimp style Connector						
X° ±2°					APPROVAL	CHECK	DRAWN	DATE			
PROJECT					2007/05/03						
DATE	REV	ECN NO	DESCRIPTION	MODIFY	APPROVAL	UNIT		SCALE	SHEET	REV	NUMBER
						mm	1:1	1/1	A	A-000	

RoHS

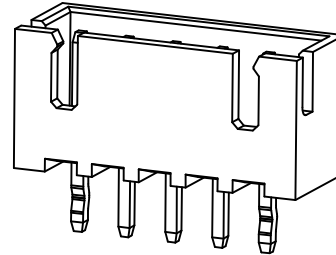
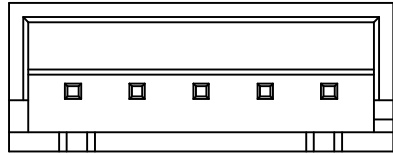

- Specifications :
- Voltage rating: 250V AC / DC
 - Current rating: 3A AC / DC
 - Withstanding voltage: 1000V AC/minute
 - Temperature range: -25°C~+85°C
 - Insulation resistance: ≥100MΩ
 - Contact resistance: ≤10mΩ
 - After environmental testing: ≤20mΩ
 - Material(Pin):Brass
 - Mates With GYA Housing: A2508H

A2508 W V X-XX K-N0 SN XX-07

① ② ③ ④ ⑤ ⑥ ⑦ ⑧ ⑨

- ① Series No.
- ② Category: W-WAFER
- ③ Welding Board Angle: V- 180°
- ④ Welding Way: Blank-DIP ;
- ⑤ Row No.-Pin No.: XX-Single Row ;
- ⑥ Special No.: K-KINK
- ⑦ Material: N0 -PA66 94V-0
- ⑧ Plating Category: SN-Bright Tin Plating
- ⑨ Color : Blank-Natural Color

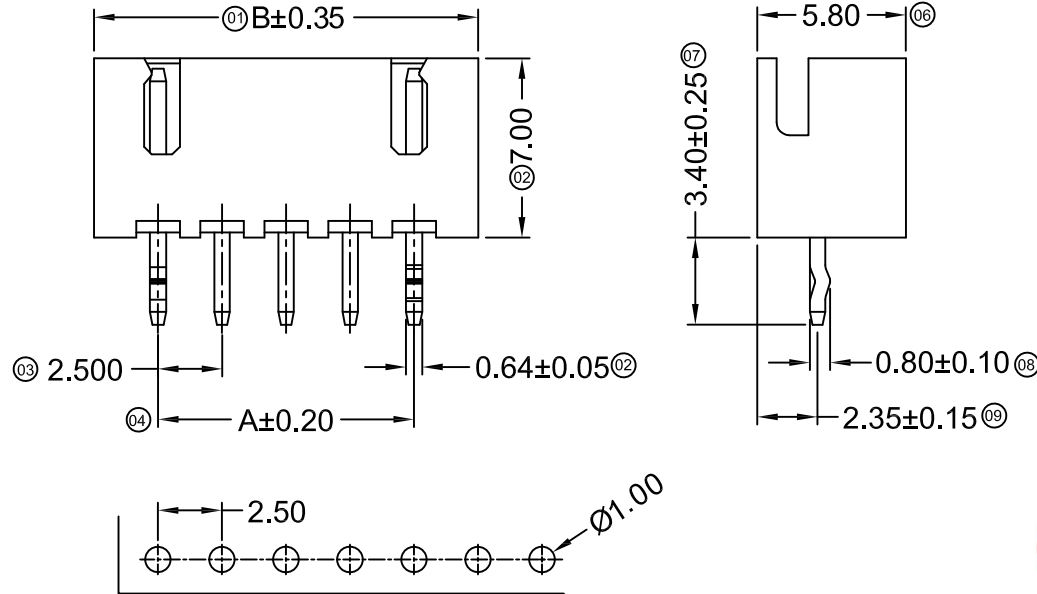

Poles	Dimensions(mm)		Poles	Dimensions(mm)	
	AB			AB	
02	2.50	7.50	12	27.50	32.50
03	5.00	10.00	13	30.00	35.00
04	7.50	12.50	14	32.50	37.50
05	10.00	15.00	15	35.00	40.00
06	12.50	17.50	16	37.50	42.50
07	15.00	20.00	17	40.00	45.00
08	17.50	22.50	18	42.50	47.50
09	20.00	25.00	19	45.00	50.00
10	22.50	27.50	20	47.50	52.50
11	25.00	30.00			

Recommended P.C.B Layout
General Tolerance±0.05



GENERAL TOLERANCE

.X ±0.30

.XX ±0.20

.XXX ±0.10

X° ±2°

PROJECT

GYA
Connectors

东莞市国亚电子有限公司
Dong Guan Guo Ya Connectors co., Ltd.

PART NO.

A2508WV-X XK-N0SN-07

TITLE

2.50mm Crimp style Connector

UNIT SCALE SHEET REV NUMBER

mm 1:1 1/1 A A-007

APPROVAL

Yangzhengguo

CHECK

Yangjinyi

DRAWN

Lvtiansheng

DATE

2018/05/30

DATE	REV	ECN NO	DESCRIPTION	MODIFY	APPROVAL

RoHS

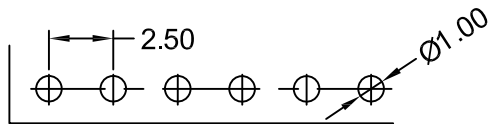
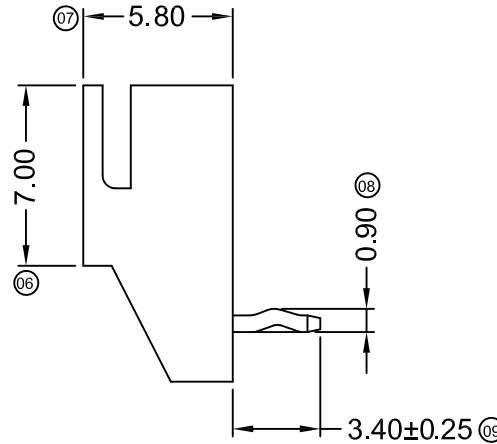
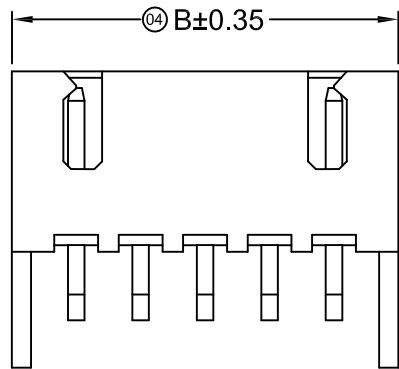
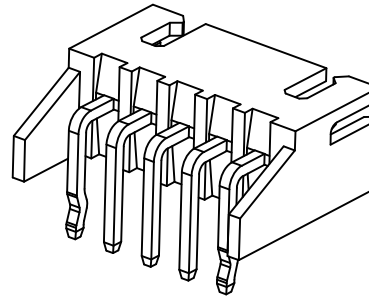
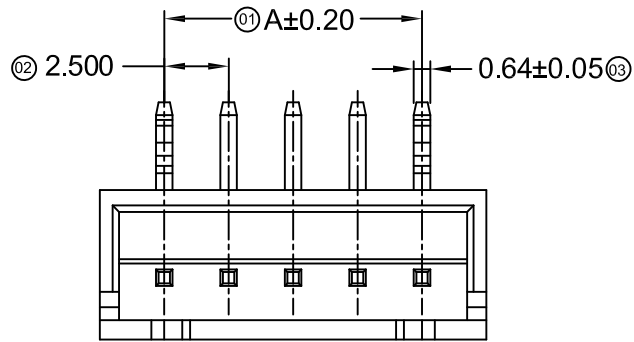

Recommended P.C.B Layout
General Tolerance±0.05



Specifications :

- Voltage rating: 250V AC / DC
- Current rating: 3A AC / DC
- Withstanding voltage: 1000V AC/minute
- Temperature range: -25°C~+85°C
- Insulation resistance: ≥1000MΩ
- Contact resistance: ≤10mΩ
- After environmental testing: ≤20mΩ
- Material(Pin):Brass
- Mates With GYA Housing:A2508H

A2508 W R X-XX K -N0 SN XX-07
① ② ③ ④ ⑤ ⑥ ⑦ ⑧ ⑨

- ① Series No.
- ② Category: W-WAFER
- ③ Welding Board Angle: R-Right Angle 90°
- ④ Welding Way: Blank-DIP ;
- ⑤ Row No.-Pin No.: XX-Single Row ;
- ⑥ Special No.: K-KINK
- ⑦ Material: N0 -PA66 94V-0
- ⑧ Plating Category: SN-Bright Tin Plating
- ⑨ Color : Blank-Natural Color

Poles	Dimensions(mm)		Poles	Dimensions(mm)	
	AB			AB	
02	2.50	7.50	12	27.50	32.50
03	5.00	10.00	13	30.00	35.00
04	7.50	12.50	14	32.50	37.50
05	10.00	15.00	15	35.00	40.00
06	12.50	17.50	16	37.50	42.50
07	15.00	20.00	17	40.00	45.00
08	17.50	22.50	18	42.50	47.50
09	20.00	25.00	19	45.00	50.00
10	22.50	27.50	20	47.50	52.50
11	25.00	30.00			

GENERAL TOLERANCE

- .X ±0.30
- .XX ±0.20
- .XXX ±0.10
- X° ±2°

PROJECT



东莞市国亚电子有限公司
Dong Guan Guo Ya Connectors co., Ltd.

APPROVAL

CHECK

DRAWN

DATE

Yangzhengguo

Yangjinyi

Lvtiansheng

2018/05/15

PART NO.

A2508WR-X XK-N0SN-07

TITLE

2.50mm Crimp style Connector

UNIT

SCALE

SHEET

REV

NUMBER

mm

1:1

1/1

A

A-007

DATE	REV	ECN NO	DESCRIPTION	MODIFY	APPROVAL
1					
2					
3					
4					

RoHS

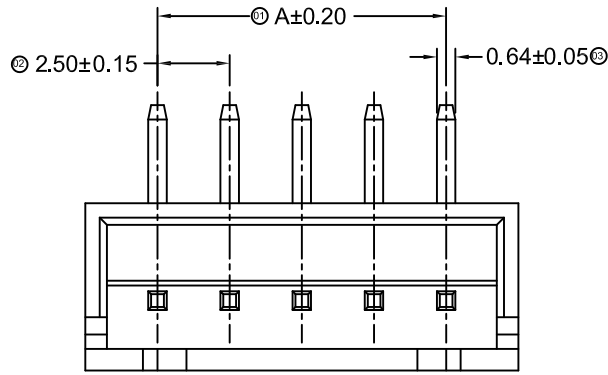

- Specifications :
- Voltage rating: 250V AC / DC
 - Current rating: 3A AC / DC
 - Withstanding voltage: 1000V AC/minute
 - Temperature range: -25°C~+85°C
 - Insulation resistance: ≥1000MΩ
 - Contact resistance: ≤10mΩ
 - After environmental testing: ≤20mΩ
 - Material(Pin):Brass
 - Mates With GYA Housing: A2508H

A2508 W R X-XX X-N0 SN XX-07

① ② ③ ④ ⑤ ⑥ ⑦ ⑧ ⑨

- ① Series No.
- ② Category: W-WAFER
- ③ Welding Board Angle: R-Right Angle 90°
- ④ Welding Way: Blank-DIP ;
- ⑤ Row No.-Pin No.: XX-Single Row ;
- ⑥ Special No.:
- ⑦ Material: N0 -PA66 94V-0
- ⑧ Plating Category: SN-Bright Tin Plating
- ⑨ Color: Blank-Natural Color

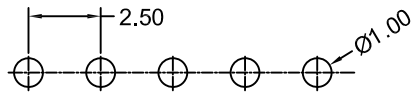
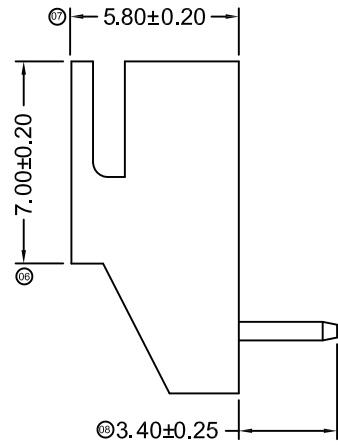
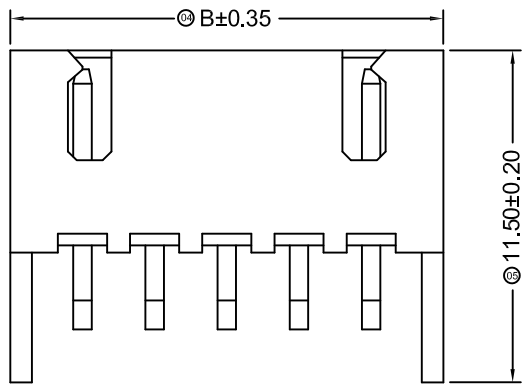

Recommended P.C.B Layout
General Tolerance±0.05

Poles	Dimensions(mm)		Poles	Dimensions(mm)	
	AB			AB	
02	2.50	7.50	12	27.50	32.50
03	5.00	10.00	13	30.00	35.00
04	7.50	12.50	14	32.50	37.50
05	10.00	15.00	15	35.00	40.00
06	12.50	17.50	16	37.50	42.50
07	15.00	20.00	17	40.00	45.00
08	17.50	22.50	18	42.50	47.50
09	20.00	25.00	19	45.00	50.00
10	22.50	27.50	20	47.50	52.50
11	25.00	30.00			

					GENERAL TOLERANCE				GYA 东莞市国亚电子有限公司 Connectors Dong Guan Guo Ya Connectors co., Ltd.				PART NO. A2508WR-XX-N0SN-07														
					.X ±0.30								TITLE 2.50 mm Crimp style Connector														
					.XX ±0.20				APPROVAL		CHECK		DRAWN		DATE		UNIT		SCALE		SHEET		REV		NUMBER		
					.XXX ±0.10				Yangzhengguo		Yangjljnl		Lvtiansheng		2018/07/02		mm		1:1		1/1		A		A-007		
					X° ±2°				PROJECT																		
DATE	REV	ECN NO	DESCRIPTION	MODIFY	APPROVAL	PROJECT																					

1 | 2 | 3 | 4 | 5 | 6 | 7 | 8

RoHS

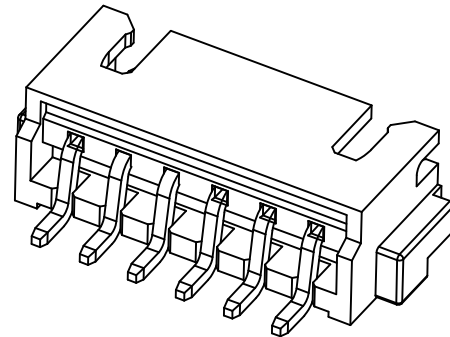
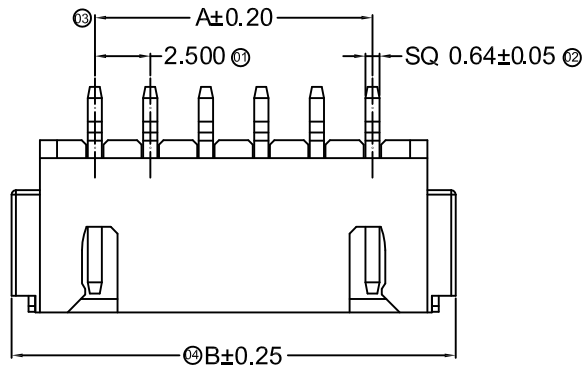

Specifications :

- Voltage rating: 250V AC / DC
- Current rating: 3A AC / DC
- Withstanding voltage: 1000V AC/minute
- Temperature range: -25°C~+85°C
- Insulation resistance: ≥1000MΩ
- Contact resistance: ≤10mΩ
- After environmental testing: ≤20mΩ

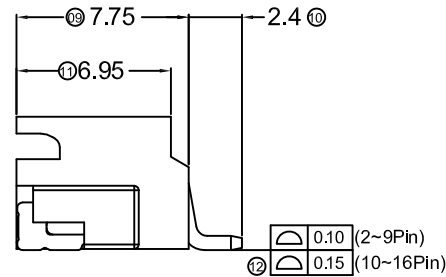
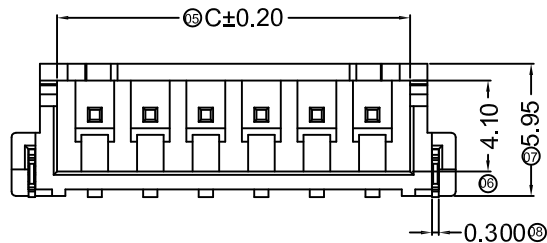

A2508 W R S-XX X-XX XX XX - S
 ① ② ③ ④ ⑤ ⑥ ⑦ ⑧

- ① Series No.
- ② Category: W-WAFER
- ③ Welding Board Angle: R-Right Angle 90°
- ④ Welding Way: S-SMT
- ⑤ Row No.-Pin No.: XX-02P~16P
- ⑥ Plug the Pin & Special No.: ▽
- ⑦ Material: 4T -PA4T UL 94V-0
- ⑧ Plating Category: SN-Bright Tin Plating V01-All Gold Flash
- ⑨ Color : Blank-Natural Color

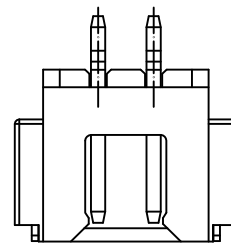
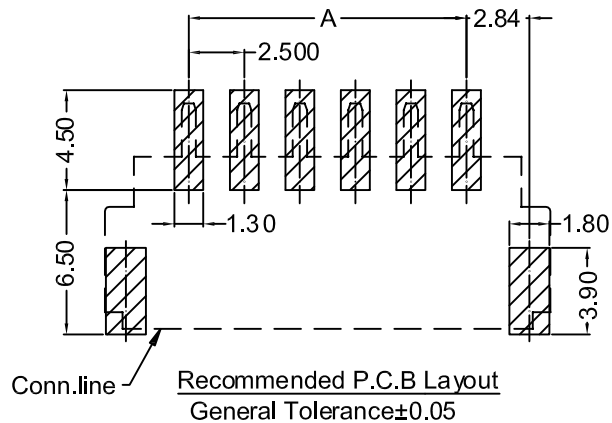

2P Shape
SCALE 1:1



Poles	Dimensions (mm)			Poles	Dimensions (mm)		
	AB		C		AB		C
02	2.50	10.00	5.90	10	22.50	30.00	25.90
03	5.00	12.50	8.40	11	25.00	32.50	28.40
04	7.50	15.00	10.90	12	27.50	35.00	30.90
05	10.00	17.50	13.40	13	30.00	37.50	33.40
06	12.50	20.00	15.90	14	32.50	40.00	35.90
07	15.00	22.50	18.40	15	35.00	42.50	38.40
08	17.50	25.00	20.90	16	37.50	45.00	40.90
09	20.00	27.50	23.40				

GENERAL TOLERANCE

.X ±0.30

.XX ±0.20

.XXX ±0.10

X° ±2°

PROJECT



东莞市国亚电子有限公司
Dong Guan Guo Ya Connectors co., Ltd.

PART NO.

A2508WRS-XX-4TXX-S

TITLE
2.50mm Crimp Style Connector

APPROVAL

CHECK

DRAWN

DATE

Yangzhengguo

Yangjinyi

Lvtiansheng

2017/06/12

UNIT

SCALE

SHEET

REV

NUMBER

mm

1:1

1/1

A

A-000

DATE	REV	ECN NO	DESCRIPTION	MODIFY	APPROVAL