

RoHS

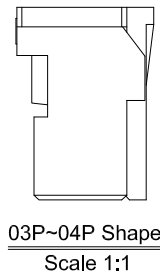
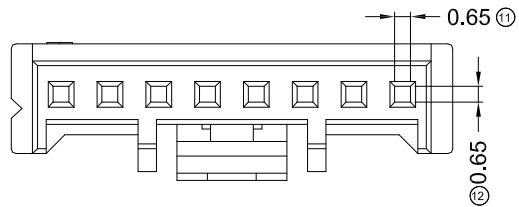
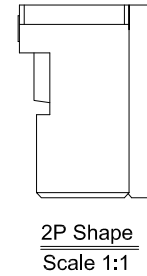
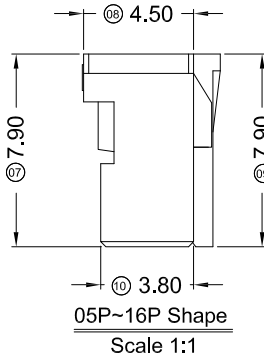
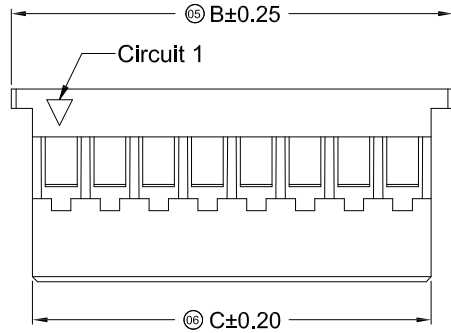
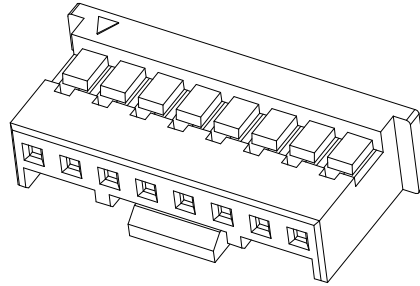
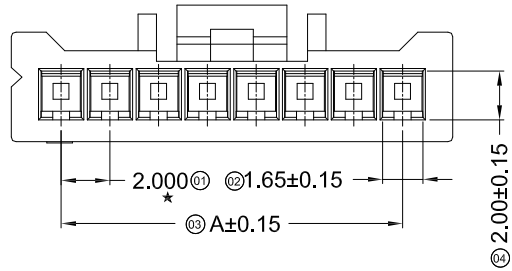

■ Specifications :

- Voltage rating: 250V AC / DC
- Current rating: 3A AC / DC
- Withstanding voltage: 800V AC/minute
- Temperature range: -40° ~+105°
- Insulation resistance: ≥1000MΩ
- Contact resistance: ≤10mΩ
- After environmental testing: ≤20mΩ
- " * " Critical dimension

- Suitable GYA Terminal: A2015T
- Suitable GYA Wafer: A2015W

A2015 H X-XX X-N0 XX XX
① ② ③ ④ ⑤ ⑥ ⑦ ⑧

- ① Series No.
- ② Category: H-HSG
- ③ Appearance type: Blank-Ordinary
- ④ Row No.-Pin No.: XX-02P~16P
- ⑤ Plug the Pin & Special No.: Blank-Ordinary
- ⑥ Material: N0-PA66 94V-0
- ⑦ Blank-Ordinary; HF-Halogen Free
- ⑧ Blank-Natural; BK-Black; RE-Red

Poles	Dimensions (mm)			Poles	Dimensions (mm)		
	A	B	C		A	B	C
02	2.00	6.10	4.34	10	18.00	22.10	20.34
03	4.00	8.10	6.34	11	20.00	24.10	22.34
04	6.00	10.10	8.34	12	22.00	26.10	24.34
05	8.00	12.10	10.34	13	24.00	28.10	26.34
06	10.00	14.10	12.34	14	26.00	30.10	28.34
07	12.00	16.10	14.34	15	28.00	32.10	30.34
08	14.00	18.10	16.34	16	30.00	34.10	32.34
09	16.00	20.10	18.34				

GENERAL TOLERANCE	
.X	±0.30
.XX	±0.20
.XXX	±0.10
X.°	±2°
PROJECT	



东莞市国亚电子有限公司
Dong Guan Guo Ya Connectors co., Ltd.

PART NO.
A2015H-XX-N0XXXX

TITLE
2.00mm Crimp Style Connector

APPROVAL	CHECK	DRAWN	DATE
Yangzhengguo	Yangjinyi	Lvtiansheng	2016/08/26

UNIT	SCALE	SHEET	REV	NUMBER
mm	1:1	1/1	A0	A-022

DATE	REV	ECN NO	DESCRIPTION	MODIFY	APPROVAL
1		2		4	5

RoHS

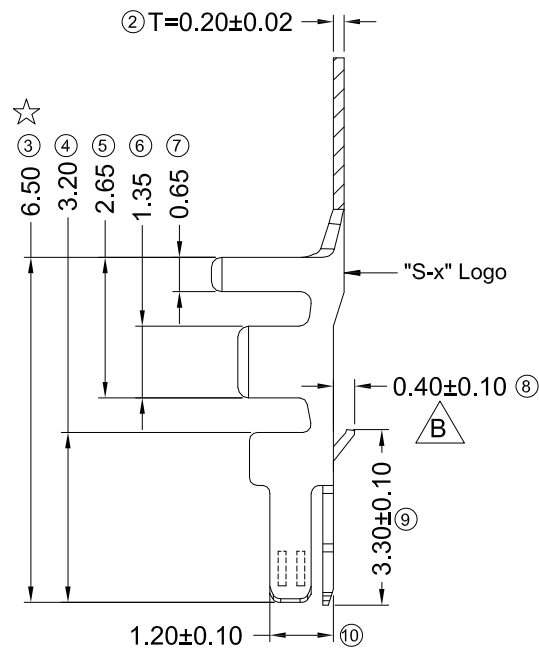
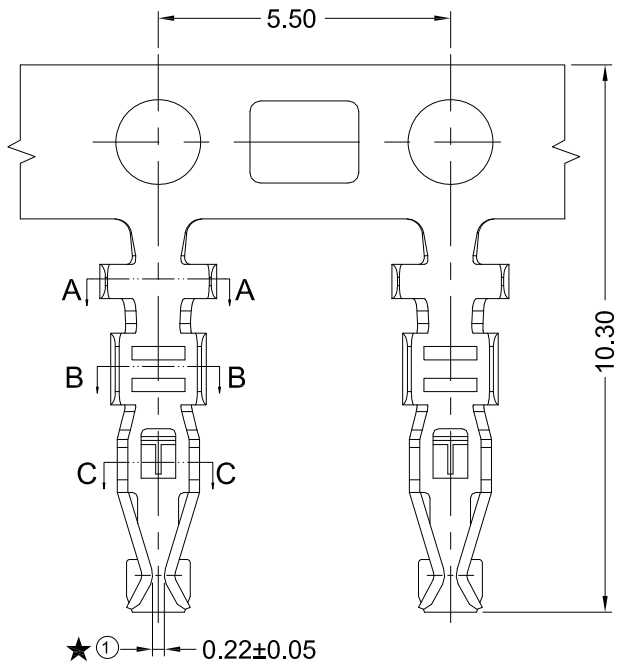

■ Specifications :

- Voltage rating: 250V AC / DC
- Current rating: 3A AC / DC
- Withstanding voltage: 800V AC/minute
- Temperature range: -40° ~+125°
- Insulation resistance: ≥1000MΩ
- Contact resistance: ≤10mΩ
- After environmental testing : ≤20mΩ
- Used In GYA Housing:2000H
- "★"Represents special characteristics
- "☆" Represents critical characteristics
- Special characteristics and critical characteristics according to 《control plan》

A2015 T H-H SN

- ① Series No.
- ② Category: T-Terminal
- ③ Appearance type: H-High feet;
- ④ Material: H-Copper Alloy(CuNi3Si1Mg)
- ⑤ Plating Style: SN-Bright Tin Plating
Ni:1~3um(40~120u")
Sn:2~5um(80-200u")

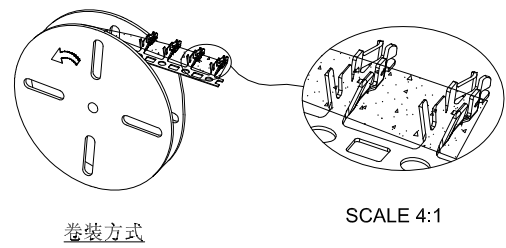
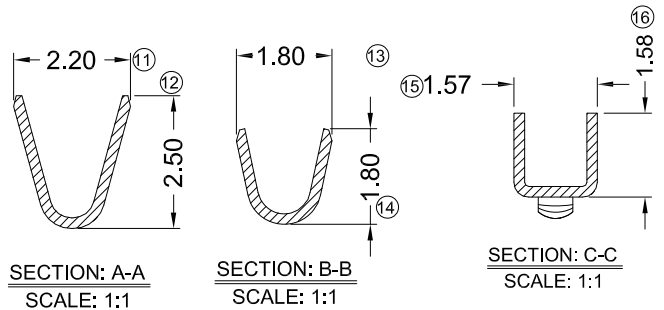

A2015TH-HSN	Copper Alloy(CuNi3Si1Mg)	0.35~0.53mm ²	1.50mm(Max)	2.20	2.50	1.80	1.80	A2015H
PART NO	Material	Wire Size	Insulation O.D	DIM a	DIM b	DIM c	DIM d	Used In GYA Housing

GENERAL TOLERANCE	
.X	±0.35
.XX	±0.25
.XXX	±0.15
X.°	±2°
PROJECT	
⊕	□

GYA 东莞市国亚电子有限公司
Connectors Dong Guan Guo Ya Connectors co., Ltd.

PART NO.
A2015TH-HSN

APPROVAL	CHECK	DRAWN	DATE
Yangzhengguo	Yangjinyi	Lvtiansheng	2016/08/26

TITLE
2.00mm Crimp Style Connectors

UNIT	SCALE	SHEET	REV	NUMBER
mm	1:1	1/1	A0	A-014

DATE	REV	ECN NO	DESCRIPTION	MODIFY	APPROVAL
1		2		3	4

RoHS

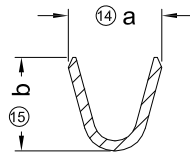
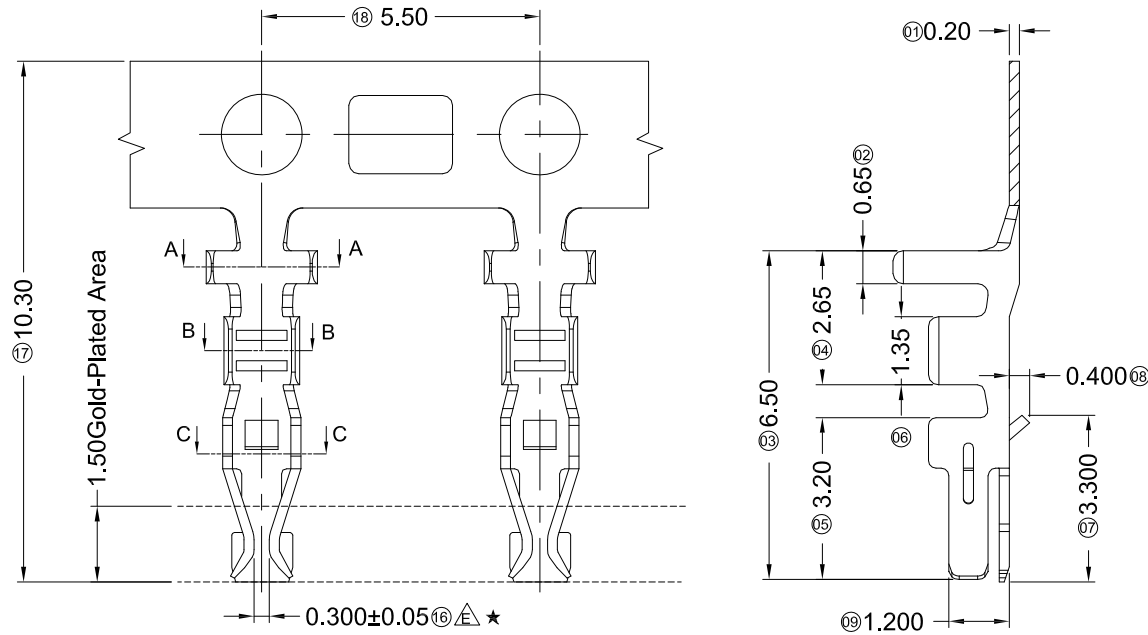

SECTION: A-A
SCALE: 1:1

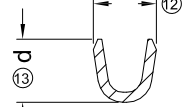

SECTION: B-B
SCALE: 1:1

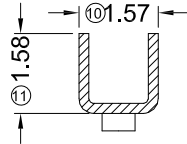

SECTION: C-C
SCALE: 1:1

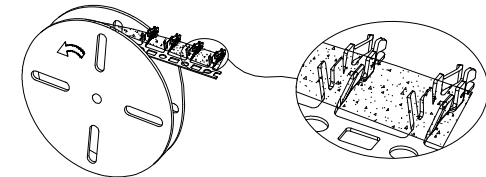

卷装方式

SCALE 4:1

Specifications :

- Voltage rating: 250V AC / DC
- Current rating: 3A AC / DC
- Withstanding voltage: 800V AC/minute
- Temperature range: -40° ~+105°
- Insulation resistance: ≥1000MΩ
- Contact resistance: ≤10mΩ
- After environmental testing: ≤20mΩ
- Used In GYA Housing: A2015H
- "★" Critical dimension

A2015 T X-P XX X-X

① ② ③ ④ ⑤ ⑥ ⑦

- ① Series No.
- ② Category : T-Terminal
- ③ Appearance type :
Blank-Ordinary; H-High feet; L-Low feet
- ④ Material: P-Phosphor bronze
- ⑤ Plating Code: G01-Contact Gold 1u"
G03-Contact Gold 3u"
SN-Bright Tin Plating
- ⑥ Plating Method : Blank-Stamping before Plating
- ⑦ Mold No./Mark/Special No.

A2015TH-PXXX		AWG#20-22 (0.5-0.35mm ²)	1.50mm(Max)	2.20	2.50	1.80	1.80
A2015T-PXXX	Phosphor bronze	AWG#22-24 (0.35-0.22mm ²)	1.50mm(Max)	2.20	2.50	1.50	1.60
A2015TL-PXXX		AWG#28-32	1.00mm(Max)	1.85	1.85	1.25	1.25
P/N	Material	Wire Size	Insulation O.D	DIM a	DIM b	DIM c	DIM d

DATE	REV	ECN NO	DESCRIPTION	MODIFY	APPROVAL
1		2		4	

GENERAL TOLERANCE	
.X	±0.30
.XX	±0.20
.XXX	±0.10
X.°	±2°
PROJECT	



东莞市国亚电子有限公司
Dong Guan Guo Ya Connectors co., Ltd.

APPROVAL	CHECK	DRAWN	DATE
Yangzhengguo	Yangjinyi	Lvtiansheng	2016/08/26

PART NO.				
A2015TX-PXX				
TITLE				
2.00mm Crimp Style Connectors				
UNIT	SCALE	SHEET	REV	NUMBER
mm	1:1	1/1	A0	A-014

RoHS

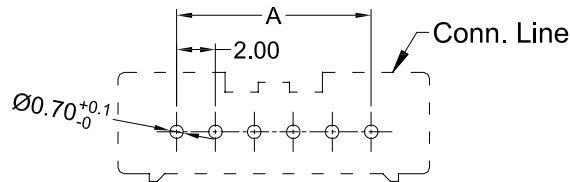
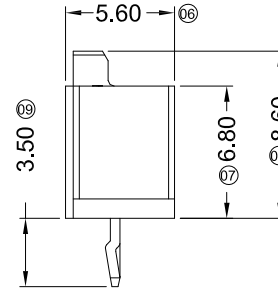
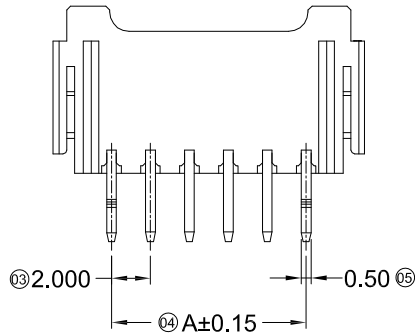
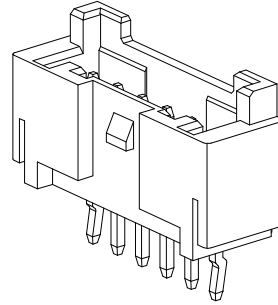
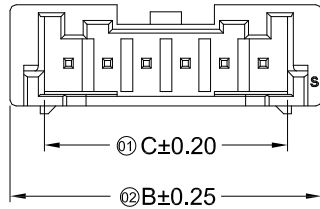

Recommended P.C.B Layout
General Tolerance±0.05

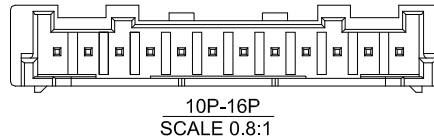
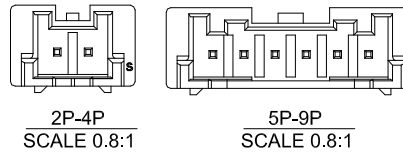

Specifications :

- Voltage rating: 250V AC / DC
- Current rating: 3A AC / DC
- Withstanding voltage: 800V AC/minute
- Temperature range: -40° ~+105°
- Insulation resistance: ≥1000MΩ
- Contact resistance: ≤10mΩ
- After environmental testing: ≤20mΩ
- Material(Pin): Brass
- Mates With GYA Housing: A2015H



A2015 W V X-XX X -9T SN XX
① ② ③ ④ ⑤ ⑥ ⑦ ⑧ ⑨

- ① Series No.
- ② Category: W-WAFER
- ③ Welding Board Angle : V- Stright 180° ;
- ④ Welding Way: Blank-DIP
- ⑤ Row No.-Pin No.: XX-02P~16P
- ⑥ Plug the Pin & Special No.: With Kink
- ⑦ Material: 9T -PA9T 94V-0
- ⑧ Plating Category: SN-Bright Tin Plating
- ⑨ Color : Blank-Natural Color

Poles	Dimensions (mm)			Poles	Dimensions (mm)		
	A	B	C		A	B	C
02	2.00	8.00	4.50	10	18.00	24.00	20.50
03	4.00	10.00	6.50	11	20.00	26.00	22.50
04	6.00	12.00	8.50	12	22.00	28.00	24.50
05	8.00	14.00	10.50	13	24.00	30.00	26.50
06	10.00	16.00	12.50	14	26.00	32.00	28.50
07	12.00	18.00	14.50	15	28.00	34.00	30.50
08	14.00	20.00	16.50	16	30.00	36.00	32.50
09	16.00	22.00	18.50				

GENERAL TOLERANCE	
.X	±0.30
.XX	±0.20
.XXX	±0.10
X.°	±2°
PROJECT	



东莞市国亚电子有限公司
Dong Guan Guo Ya Connectors co., Ltd.

PART NO.
A2015WV-XX-9TSN

TITLE
2.00mm Crimp Style Connector

APPROVAL	CHECK	DRAWN	DATE
Yangzhengguo	Yangjinyi	Lvtiansheng	2016/08/26

UNIT	SCALE	SHEET	REV	NUMBER
mm	1:1	1/1	A0	A-000

DATE	REV	ECN NO	DESCRIPTION	MODIFY	APPROVAL

RoHS

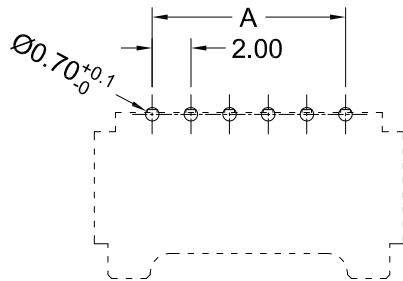
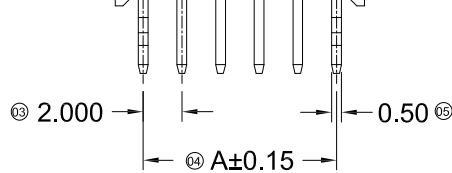
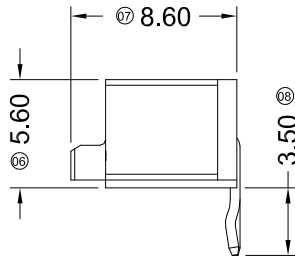
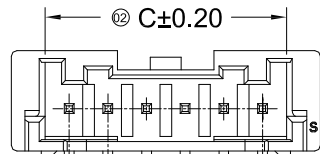
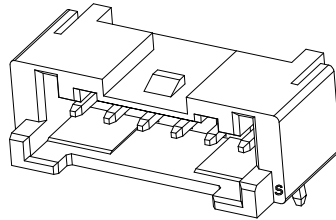
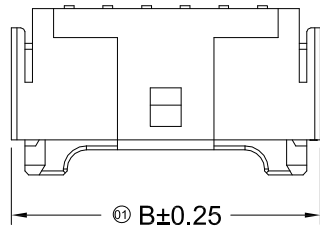

Recommended P.C.B Layout
General Tolerance±0.05

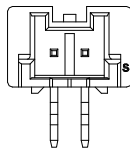

2P-4P
SCALE 0.8:1

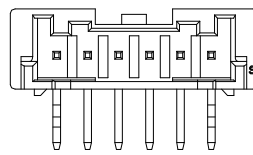

5P-9P
SCALE 0.8:1

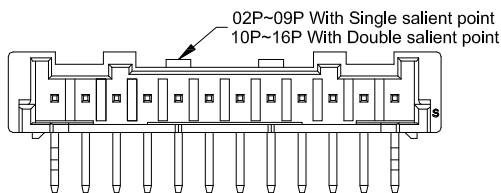

10P-16P
SCALE 0.8:1

■ Specifications :

- Voltage rating: 250V AC / DC
- Current rating: 3A AC / DC
- Withstanding voltage: 800V AC/minute
- Temperature range: -40° ~+105°
- Insulation resistance: ≥1000MΩ
- Contact resistance: ≤10mΩ
- After environmental testing: ≤20mΩ
- Material(Pin): Brass
- Mates With GYA Housing: A2015H

A2015 W R X-XX X -9T SN XX
① ② ③ ④ ⑤ ⑥ ⑦ ⑧ ⑨

- ① Series No.
- ② Category: W-WAFER
- ③ Welding Board Angle : R-Right Angle 90°
- ④ Welding Way: Blank-DIP
- ⑤ Row No.-Pin No.: XX-02P~16P
- ⑥ Plug the Pin & Special No.
- ⑦ Material: 9T -PA9T 94V-0
- ⑧ Plating Code: SN-Bright Tin Plating
- ⑨ Color : Blank-Natural Color



Poles	Dimensions (mm)			Poles	Dimensions (mm)		
	A	B	C		A	B	C
02	2.00	8.00	4.50	10	18.00	24.00	20.50
03	4.00	10.00	6.50	11	20.00	26.00	22.50
04	6.00	12.00	8.50	12	22.00	28.00	24.50
05	8.00	14.00	10.50	13	24.00	30.00	26.50
06	10.00	16.00	12.50	14	26.00	32.00	28.50
07	12.00	18.00	14.50	15	28.00	34.00	30.50
08	14.00	20.00	16.50	16	30.00	36.00	32.50
09	16.00	22.00	18.50				

DATE	REV	ECN NO	DESCRIPTION	MODIFY	APPROVAL

GENERAL TOLERANCE	
.X	±0.30
.XX	±0.20
.XXX	±0.10
X.°	±2°
PROJECT	

	东莞市国亚电子有限公司 Dong Guan Guo Ya Connectors co., Ltd.			
	APPROVAL	CHECK	DRAWN	DATE
Yangzhengguo	Yangjinyi	Lvtiansheng	2016/08/26	

PART NO. A2015WR-XX-9TSN				
TITLE 2.00mm Crimp Style Connector				
UNIT	SCALE	SHEET	REV	NUMBER
mm	1:1	1/1	A0	A-000

RoHS

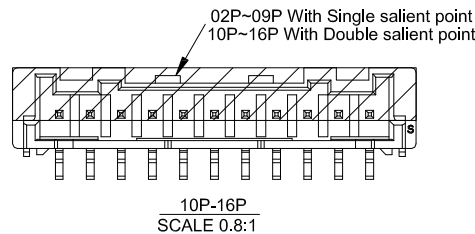
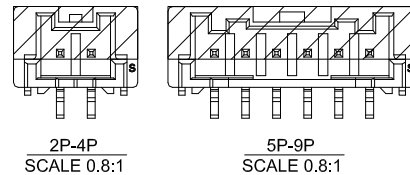
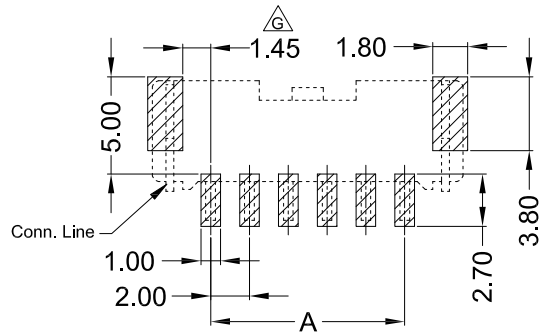
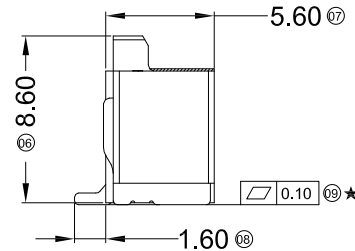
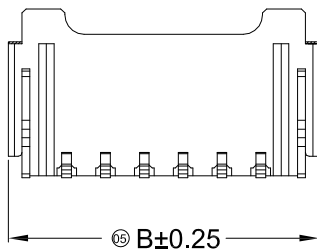
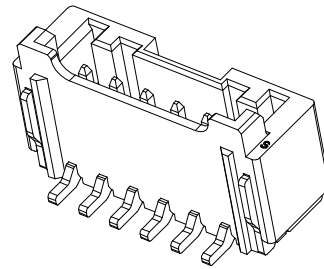
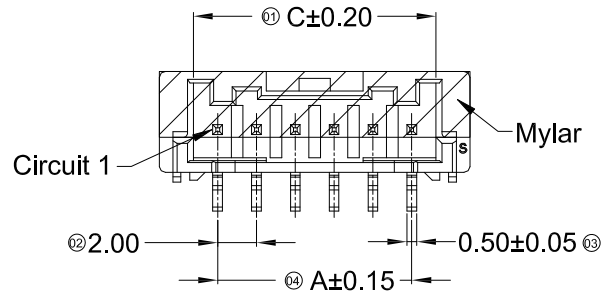

Specifications :

- Voltage rating: 250V AC / DC
- Current rating: 3A AC / DC
- Withstanding voltage: 800V AC/minute
- Temperature range: -40° ~+105°
- Insulation resistance: ≥1000MΩ
- Contact resistance: ≤10mΩ
- After environmental testing : ≤20mΩ
- Material(Pin) : Brass
- Material(Solder Tabs) : Brass
- Mates With GYA Housing : A2015H
- " ★ " Critical dimension

A2015 W V S-XX X -9T SW XX X
 ① ② ③ ④ ⑤ ⑥ ⑦ ⑧ ⑨ ⑩

- ① Series No.
- ② Category: W-WAFER
- ③ Connector type: V-Straight 180°
- ④ Mounting type: S-SMT
- ⑤ Row No.-Pin No per row: XX-02P~16P
- ⑥ Plug the Pin & Special No.
- ⑦ Material: 9T -PA9T 94V-0
LP -LCP 94V-0
- ⑧ Plating Code: SN-Bright Tin ; SW-Matte Tin
- ⑨ Color : Blank-Natural Color
- ⑩ Packing: Blank-Reel ,With Mylar
R-Reel ,Without Mylar

Poles	Dimensions (mm)			Poles	Dimensions (mm)		
	A	B	C		A	B	C
02	2.00	8.00	4.50	10	18.00	24.00	20.50
03	4.00	10.00	6.50	11	20.00	26.00	22.50
04	6.00	12.00	8.50	12	22.00	28.00	24.50
05	8.00	14.00	10.50	13	24.00	30.00	26.50
06	10.00	16.00	12.50	14	26.00	32.00	28.50
07	12.00	18.00	14.50	15	28.00	34.00	30.50
08	14.00	20.00	16.50	16	30.00	36.00	32.50
09	16.00	22.00	18.50				

GENERAL TOLERANCE	
.X	±0.30
.XX	±0.20
.XXX	±0.10
X.°	±2°
PROJECT	



东莞市国亚电子有限公司
 Dong Guan Guo Ya Connectors co., Ltd.

APPROVAL	CHECK	DRAWN	DATE
Yangzhengguo	Yangjinyi	Lvtiansheng	2016/08/26

PART NO.
A2015WVS-XX-XXSWXXX

TITLE
2.00mm Crimp Style Connector

UNIT	SCALE	SHEET	REV	NUMBER
mm	1:1	1/1	A0	A-000

DATE	REV	ECN NO	DESCRIPTION	MODIFY	APPROVAL
1					

RoHS

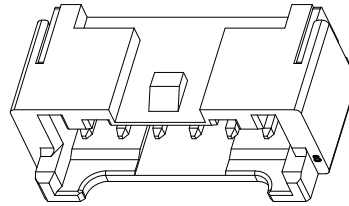
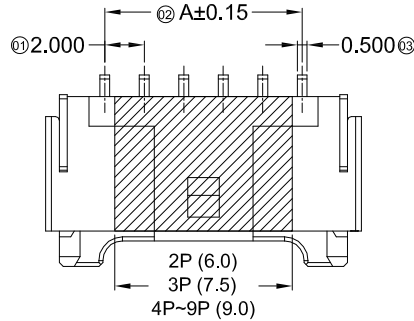

Specifications :

- Voltage rating: 250V AC / DC
- Current rating: 3A AC / DC
- Withstanding voltage: 800V AC/minute
- Temperature range: -40° ~+105°
- Insulation resistance: ≥1000M Ω
- Contact resistance: ≤10m Ω
- After environmental testing : ≤20mΩ

- Material(Pin) : Brass
- Material(Solder Tabs) : Brass
- Mates With GYA Housing : A2015H

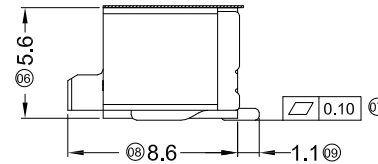
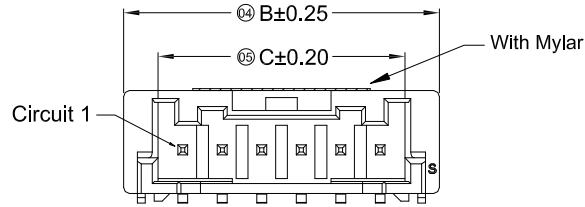

A2015 W R S-XX X -XX SW XX X
 ① ② ③ ④ ⑤ ⑥ ⑦ ⑧ ⑨ ⑩

- ① Series No.
- ② Category : W-WAFER
- ③ Connector type : R-Right Angle 90°
- ④ Mounting type: S-SMT
- ⑤ Row No.-Pin No per row: XX-02P~16P
- ⑥ Special No.
- ⑦ Material: 9T -PA9T 94V-0; LP -LCP 94V-0
- ⑧ Plating code: SW- Matte Tin
- ⑨ Color : Blank-Natural Color ; BK-Black Color
- ⑩ Packing: Blank-Reel ,With Mylar
R-Reel ,Without Mylar

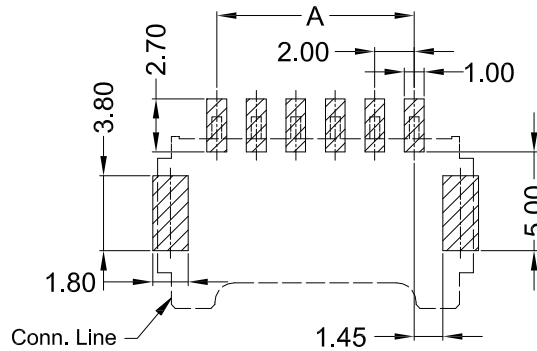

Recommended P.C.B Layout
 General Tolerance±0.05

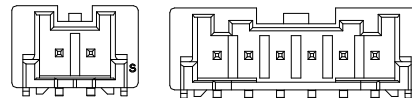

2P-4P
 SCALE 1:0.8

5P-9P
 SCALE 1:0.8

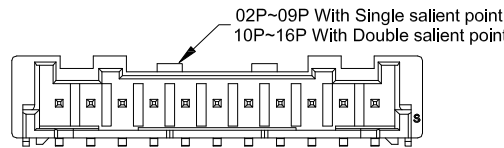

10P-16P
 SCALE 1:0.8

Poles	Dimensions (mm)			Poles	Dimensions (mm)		
	A	B	C		A	B	C
02	2.00	8.00	4.50	10	18.00	24.00	20.50
03	4.00	10.00	6.50	11	20.00	26.00	22.50
04	6.00	12.00	8.50	12	22.00	28.00	24.50
05	8.00	14.00	10.50	13	24.00	30.00	26.50
06	10.00	16.00	12.50	14	26.00	32.00	28.50
07	12.00	18.00	14.50	15	28.00	34.00	30.50
08	14.00	20.00	16.50	16	30.00	36.00	32.50
09	16.00	22.00	18.50				

GENERAL TOLERANCE

.X ±0.30

.XX ±0.20

.XXX ±0.10

X.° ±2°

PROJECT



东莞市国亚电子有限公司
 Dong Guan Guo Ya Connectors co., Ltd.

APPROVAL

CHECK

DRAWN

DATE

Yangzhengguo

Yangjinyi

Lvtiansheng

2016/08/26

PART NO.

A2015WRS-XX-XXSWXXX

TITLE

2.00mm Crimp Style Connector

UNIT

mm

SCALE

1:1

SHEET

1/1

REV

A0

NUMBER

A-000

DATE

REV

ECN NO

DESCRIPTION

MODIFY

APPROVAL

1

2

3

4

5

6

7

8