

RoHS

包装图

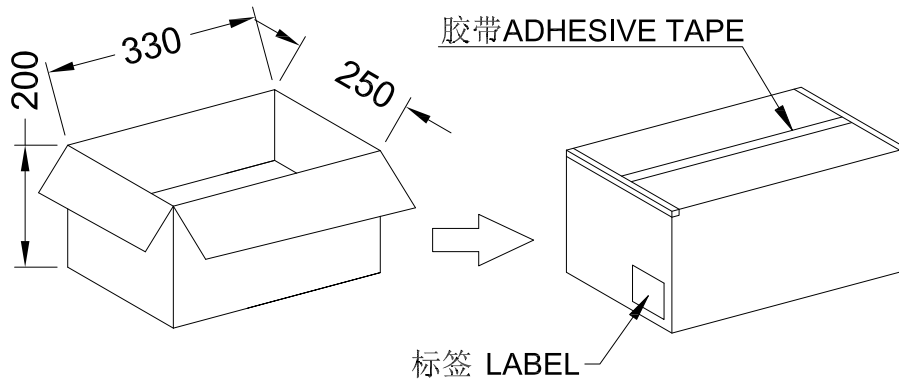
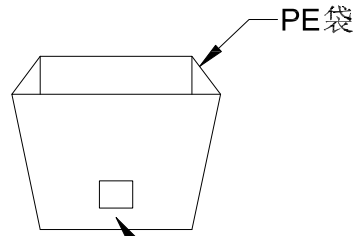
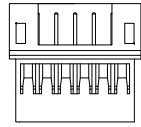

Note注解:

1. Put Housing in a PE bag, PE bag gauge for: 130 * 135 * 0.10 mm, Packing detail see the table below
将 Housing放入PE袋内, PE袋规为:130*135*0.10mm, 详细包装见下表
2. Put PE bag packed products in specifications of 330 * 250 * 300 mm cartons, Packing detail see the table below
将装好产品的PE袋放入规格为330*250*200mm的纸箱内, 详细包装见下表
3. Label depends on customer request, carton opening joint with transparent tape
标签依客户要求而定, 纸箱开口处用透明胶带贴合.

Poles	Bag PCS	CARTON Bag	CARTON PCS	Poles	Bag PCS	CARTON Bag	CARTON PCS
02	1000	75	75K	09	1000	75	75K
03	1000	75	75K	10	1000	75	75K
04	1000	75	75K	11	1000	75	75K
05	1000	75	75K	12	1000	75	75K
06	1000	75	75K	13	1000	75	75K
07	1000	75	75K	14	1000	75	75K
08	1000	75	75K	15	1000	75	75K

DATE	REV	ECN NO.	DESCRIPTION	MODIFY	APPROVAL
1					
2					
3					
4					

GENERAL TOLERANCE	
.X	±0.30
.XX	±0.20
.XXX	±0.10
X°	±0.2°
视角	

GYA 东莞市国亚电子有限公司
Connectors Dong Guan Guo Ya Connectors co., Ltd.

APPROVAL	CHECK	DRAWN	DATE
Yangzhengguo	Yangjinyi	Lvtiansheng	2016/08/26

PART NO.				
A2014H-XXX				
TITLE:				
2.00mm Housing Package				
UNIT	SCALE	SHEET	REV	NUMBER
mm	1:1	1/1	A0	A-106

F
E
D
C
B
A

F
E
D
C
B
A

1 2 3 4 5 6 7 8

1 2 3 4 5 6 7 8

RoHS

包装图

Note注解:

- Quantity 数量:
10K PCS/REEL 一卷10K/PCS
10 REEL/BOX 一箱10卷
100K PCS/BOX 一箱100K/PCS
- Each reel and outer box must be labeled and Eco-Label Respectively labeled
每盘和外箱都必须有标签及环保标签分别标示
- Terminal winding direction as shown
端子缠绕方向如左图所示
- There shall be no dirt such as deformation phenomenon, Mantissa box fillers must be used
每箱不可有脏污, 变形现象, 尾数箱必须用填充物
- Carton material: K=K, Carton thickness: 6~7mm
纸箱材质:K=K, 纸箱厚度:6~7mm

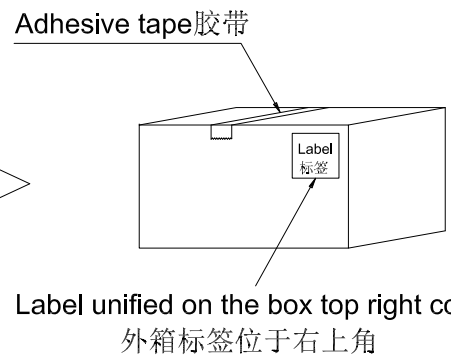
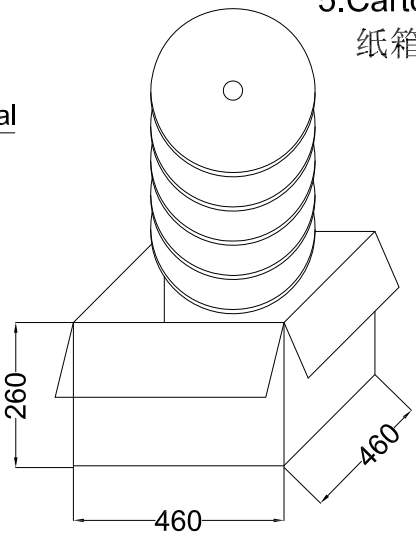
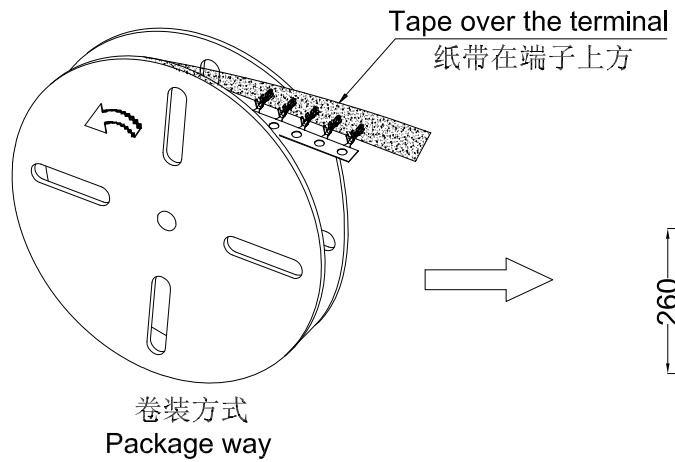
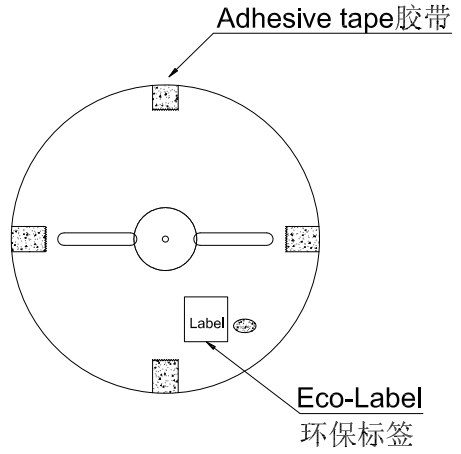

GENERAL TOLERANCE				GYA Connectors	东莞市国亚电子有限公司 Dong Guan Guo Ya Connectors co., ltd.			PART NO.			
.X ±0.30								A2014T-XXX			
.XX ±0.20					TITLE:						
.XXX ±0.10					APPROVAL			2.00mm Terminal Packing			
X° ±0.2°				Yangzhengguo		Yangjinyi		Lvtiansheng		2016/08/26	
DATE	REV	ECN NO.	DESCRIPTION	MODIFY	APPROVAL	UNIT	SCALE	SHEET	REV	NUMBER	
1						mm	1:1	1/1	A0	A-000	