

RoHS

Specifications:

Electrical
 Rated Voltage: 100V AC,DC
 Rated Current: 1A
 Withstand Voltage: 250V AC/minute
 Contact Resistance: 20mΩ (MAX.)
 Insulation Resistance: 100MΩ (MIN.)
 Temperature Range: -25°C~+85°C

Material and Finish:

Circuits: 02-15,20,30
 Material: NYLON 66 UL94V-0
 Use With:A1252T
 Mates With:A1252W;

Dimensional & Ordering Information:

cir-cuits	Part No.	Dimension mm			BAG/pcs
		A	B	C	
02	A1252H-02	1.25	2.72	5.72	1000
03	A1252H-03	2.50	3.97	6.97	1000
04	A1252H-04	3.75	5.22	8.22	1000
05	A1252H-05	5.00	6.47	9.47	1000
06	A1252H-06	6.25	7.72	10.72	1000
07	A1252H-07	7.50	8.97	11.97	1000
08	A1252H-08	8.75	10.22	13.22	1000
09	A1252H-09	10.00	11.47	14.47	1000
10	A1252H-10	11.25	12.72	15.72	1000
11	A1252H-11	12.50	13.97	16.97	1000
12	A1252H-12	13.75	15.22	18.22	1000
14	A1252H-14	16.25	17.72	20.72	1000
15	A1252H-15	17.50	18.97	21.97	1000
20	A1252H-20	23.75	25.22	28.22	1000
30	A1252H-30	36.25	37.72	40.72	1000

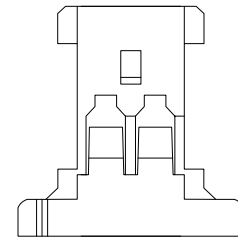
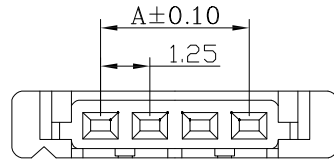

2P

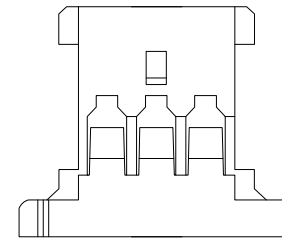
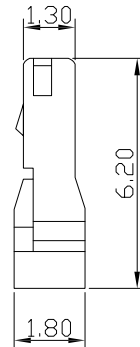
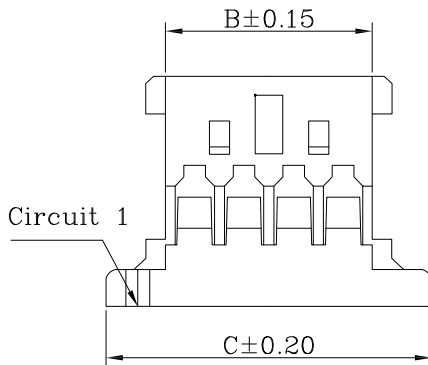

3P

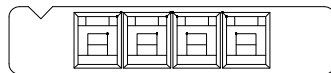

					GENERAL TOLERANCE		GYA 东莞市国亚电子有限公司 Connectors Dong Guan Guo Ya Connectors co., Ltd.		PART NO. A1252H-XXX				
					.X ±0.35				TITLE 1.25 mm Crimp Style Connectors				
					.XX ±0.25								
					.XXX ±0.15				APPROVAL		CHECK	DRAWN	DATE
					X.° ±2°		PROJECT		Yangzhengguo	Yangzhengyi	Lvtiansheng	2016/08/26	
DATE	REV	ECN NO.	DESCRIPTION	MODIFY	APPROVAL	PROJECT							

1 2 3 4 5 6 7 8

RoHS

Specifications:

Electrical
 Rated Voltage: 100V AC,DC
 Rated Current: 1A
 Withstand Voltage: 250V AC/minute
 Contact Resistance: 20mΩ (MAX.)
 Insulation Resistance: 100MΩ (MIN.)
 Temperature Range: -25°C~+85°C
 Material and Finish:
 Use With:A1252H

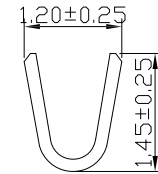
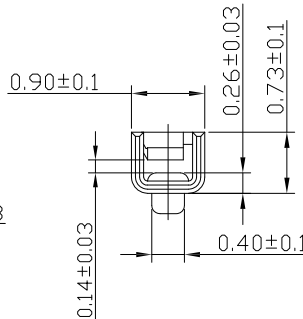
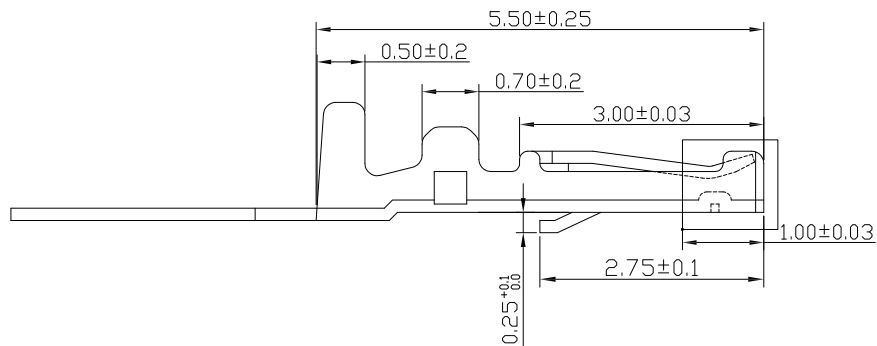
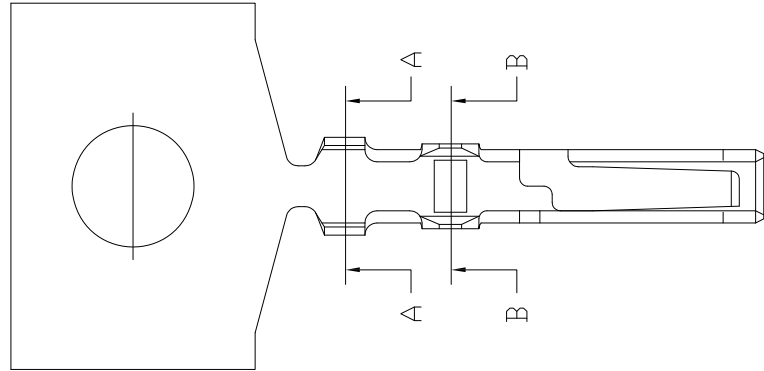

SEC:A-A

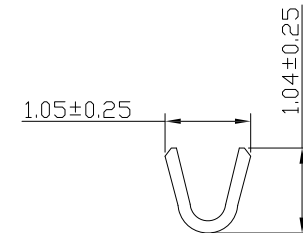

SEC:B-B

Material	Finish	Wire Range	Insulation O.D	Qty/reel
Phosphor bronze	Tin/Gold-plated	AWG#28-#32	1.2~1.05mm	15,000pcs

GENERAL TOLERANCE	
.X	±0.35
.XX	±0.25
.XXX	±0.15
X.°	±2°
PROJECT	



东莞市国亚电子有限公司
 Dong Guan Guo Ya Connectors co., Ltd.

PART NO.
 A1252T-XXX

TITLE
 1.25 mm Crimp Style Connectors

APPROVAL	CHECK	DRAWN	DATE
Yangzhengguo	Yangzhengyi	Lviansheng	2016/08/26

UNIT	SCALE	SHEET	REV	NUMBER
mm	1:1	1/1	A0	A-025

DATE	REV	ECN NO.	DESCRIPTION	MODIFY	APPROVAL

RoHS

pitch 90° Wafer - SMT TYPE

Reference Informations:

*Material: Pin: Brass/Gold-plated

Solder Tabs: Brass/Tin-flash

Wafer: Nylon 6T, UL94V-0

*Mates with GYA A1252 series Housing

*Temperature range: -25°C ~ +85°C

Ordering Information & Dimensions

PART NO.	Dimensions		
	A	B	C
02P	1.25	7.65	7.60
03P	2.50	8.90	8.85
04P	3.75	10.15	10.10
05P	5.00	11.40	11.35
06P	6.25	12.65	12.60
07P	7.50	13.90	13.85
08P	8.75	15.15	15.10
09P	10.00	16.40	16.35
10P	11.25	17.65	17.55
11P	12.50	18.90	18.85
12P	13.75	20.15	20.10
13P	15.00	21.40	21.35
14P	16.25	22.65	22.60
15P	17.50	23.90	23.85
16P	18.75	25.15	25.10
20P	23.75	30.15	30.10
30P	36.25	42.65	42.60

P.C.B. LAYOUT

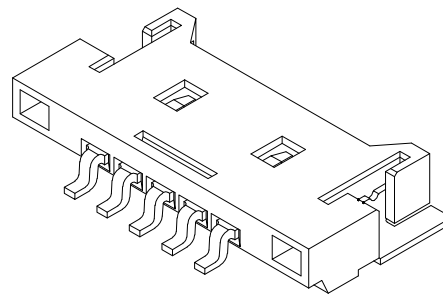
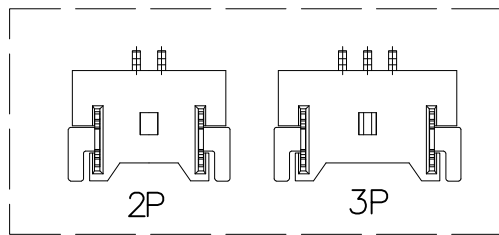
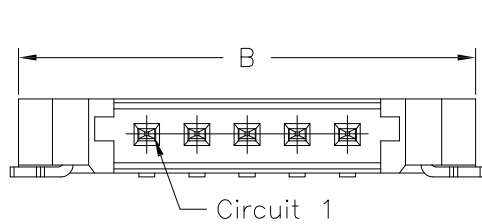
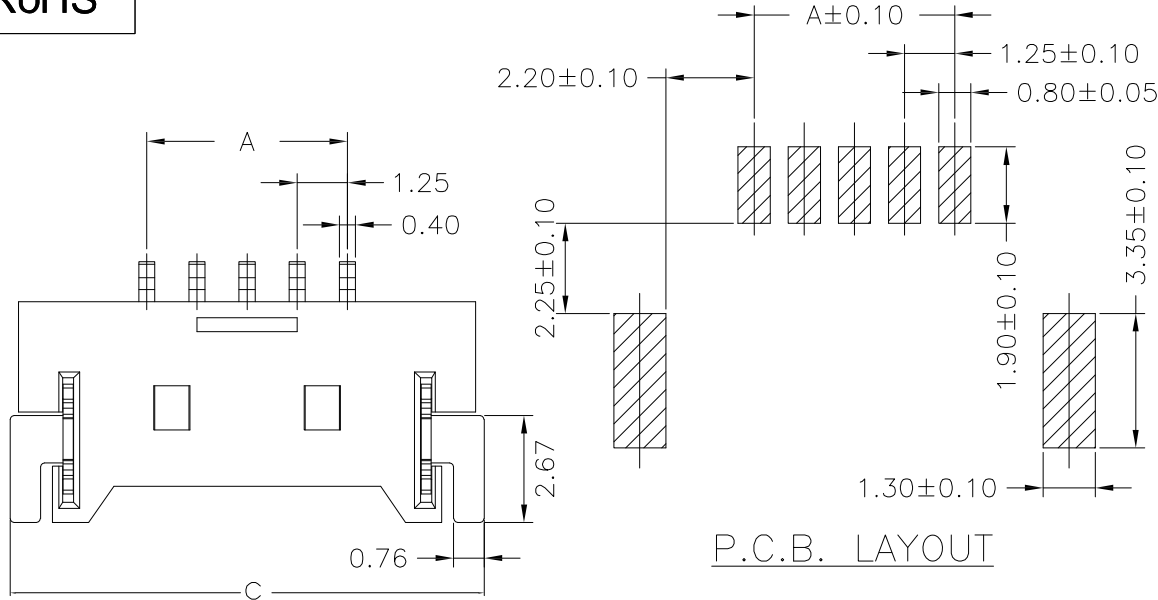

GENERAL TOLERANCE

.X	±0.30
.XX	±0.20
.XXX	±0.10
X.°	±2°

PROJECT

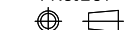

东莞市国亚电子有限公司
Dong Guan Guo Ya Connectors co., Ltd

APPROVAL

Yangzhengguo

CHECK

Yangzhengyi

DRAWN

Lvtiansheng

DATE

2016/08/26

PART NO.

A1 252WRS-XXX

TITLE

1.25 mm Crimp Style Connectors

UNIT	SCALE	SHEET	REV	NUMBER
mm	1:1	1/1	A0	A-106

DATE	REV	ECN NO	DESCRIPTION	MODIFY	APPROVAL
1					
2					