

RoHS

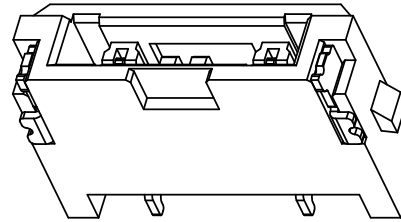

■ Specifications :

- Voltage rating: 300V AC / DC
- Current rating: 3A AC / DC
- Withstanding voltage: 1700V AC/minute
- Temperature range: -55°C~+105°C
- Insulation resistance: ≥1000MΩ
- Contact resistance: ≤20mΩ
- After environmental testing: ≤40mΩ

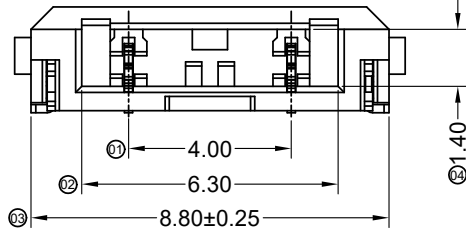
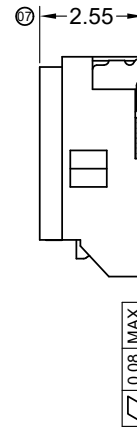
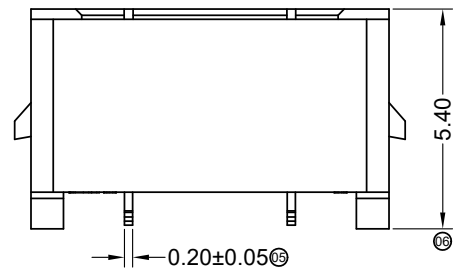

4001 W F X -02 X -LP SN XX

① ② ③ ④ ⑤ ⑥ ⑦ ⑧ ⑨

- ① Series No
- ② Category: W-WAFER
- ③ Welding Board Angle: F-Female
- ④ Welding Way: Blank-SMT
- ⑤ Row No.-Pin No.: XX-Single Row
- ⑥ Plug the Pin & Special No.
- ⑦ Material: LP -LCP 94V-0
- ⑧ Plating Category: SN-Bright Tin Plating
- ⑨ Color : Blank-Natural Color

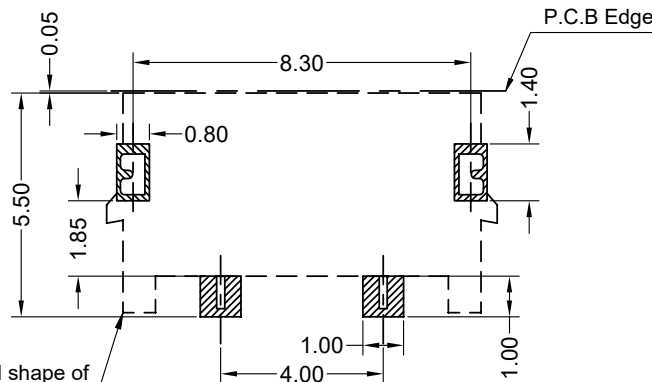

Recommended P.C.B Layout
General Tolerance±0.05

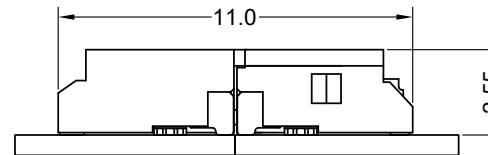

Assembly Layout



4001WF-02-LPSN	LCP UL 94V-0	Phosphor Bronze	Tin-Plated	Brass	Tin-Plated
PART NO	Material	Material(Pin)	Finish(Pin)	Material (Solder Tab)	Finish (Solder Tab)

					<p>GENERAL TOLERANCE</p> <p>.X ±0.30</p> <p>.XX ±0.20</p> <p>.XXX ±0.10</p> <p>X.° ±2°</p>				<p>APPROVAL</p> <p>YANG</p>				<p>CHECK</p> <p>TIAN</p>				<p>DRAWN</p> <p>TIAN</p>				<p>DATE</p> <p>2014/03/04</p>			
					<p>PROJECT</p>				<p>APPROVAL</p> <p>YANG</p>				<p>CHECK</p> <p>TIAN</p>				<p>DRAWN</p> <p>TIAN</p>				<p>DATE</p> <p>2014/03/04</p>			
DATE	REV	ECN NO	DESCRIPTION	MODIFY	APPROVAL																			



东莞市国亚电子有限公司
DONGGUO GUOYA ELECTRONICS CO.,LTD

PART NO.
4001WF-02-LPSN

TITLE
4.00mm BTB Style Connectors

UNIT	SCALE	SHEET	REV	NUMBER
mm	1:1	1/1	A0	A-106

RoHS

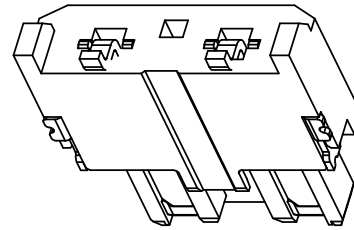
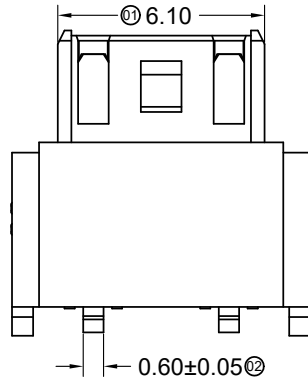

- Specifications :
- Voltage rating: 300V AC / DC
 - Current rating: 3A AC / DC
 - Withstanding voltage: 1700V AC/minute
 - Temperature range: -55°C~+105°C
 - Insulation resistance: ≥1000MΩ
 - Contact resistance: ≤20mΩ
 - After environmental testing: ≤40mΩ

4001 W M X -02 X -LP SN XX
 ① ② ③ ④ ⑤ ⑥ ⑦ ⑧ ⑨

- ① Series No
- ② Category: W-WAFER
- ③ Welding Board Angle: M-Male
- ④ Welding Way: Blank-SMT
- ⑤ Row No.-Pin No.: XX-Single Row
- ⑥ Plug the Pin & Special No.
- ⑦ Material: LP -LCP 94V-0
- ⑧ Plating Category: SN-Bright Tin Plating
- ⑨ Color : Blank-Natural Color

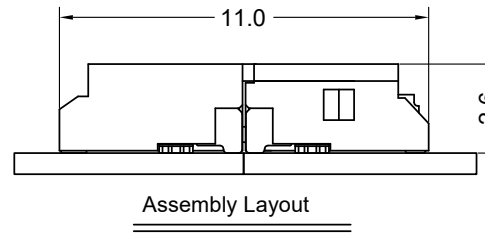
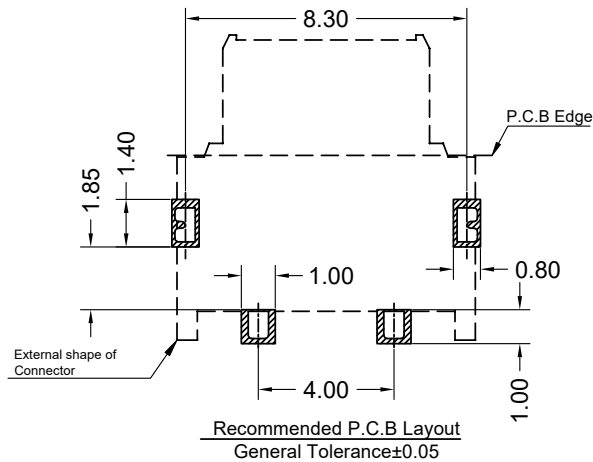
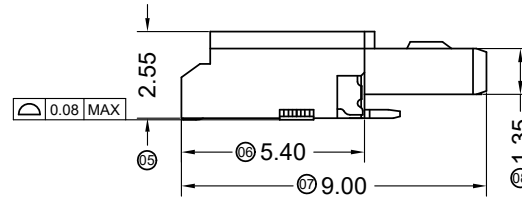
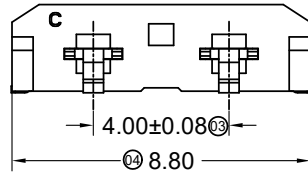

4001WM-02-LPSN	LCP UL 94V-0	Phosphor Bronze	Tin-Plated	Brass	Tin-Plated
PART NO	Material	Material(Pin)	Finish(Pin)	Material (Solder Tab)	Finish (Solder Tab)

					GENERAL TOLERANCE	东莞市国亚电子有限公司 DONGGUO GUOYA ELECTRONICS CO.,LTD				PART NO. 4001WM-02-LPSN				
					.X ±0.30					TITLE 4.00mm BTB Style Connectors				
					.XX ±0.20	APPROVAL	CHECK	DRAWN	DATE	UNIT SCALE SHEET REV NUMBER				
					.XXX ±0.10	YANG	TIAN	TIAN	2014/03/04	mm 1:1 1/1 A0 A-106				
					X.° ±2°									
DATE	REV	ECN NO	DESCRIPTION	MODIFY	APPROVAL	PROJECT								