

RoHS

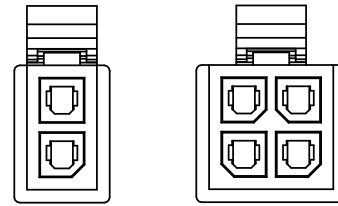

■ Specifications :

- Voltage rating: 250V AC / DC
- Current rating: 5A Max AC / DC
- Withstanding voltage: 1000V AC/minute
- Temperature range: -40°C~+105°C
- Insulation resistance: ≥1000MΩ
- Contact resistance: ≤10mΩ
- After environmental testing: ≤20mΩ
- Suitable GYA Terminal: 3025TF Mates
- With GYA Wafer: 3025W
- "★"Critical dimension

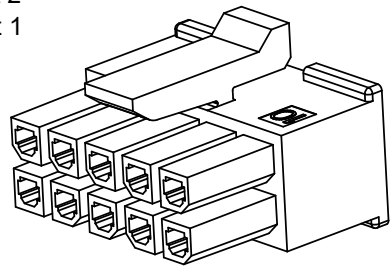
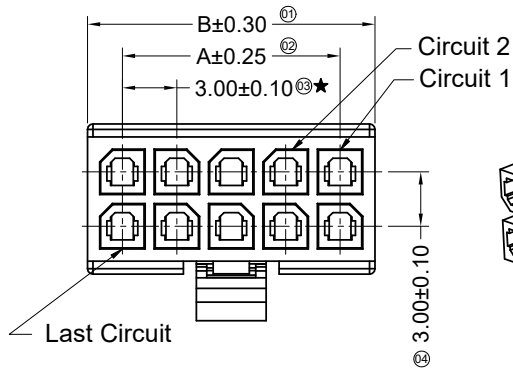
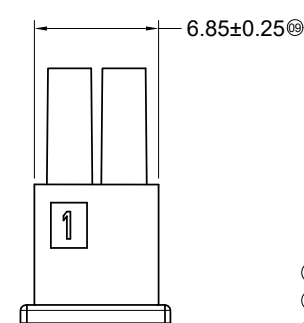
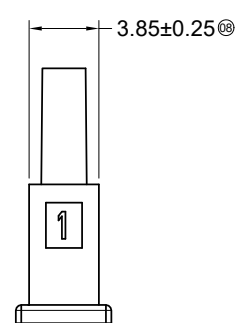
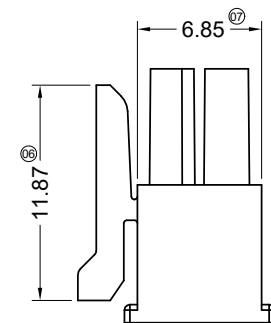
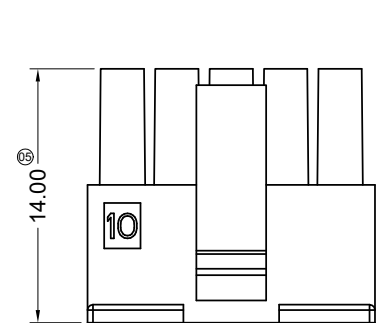

2*01PIN

2*02PIN

3025 H M-2*XX-N0 XX XX-00

① ② ③ ④ ⑤ ⑥ ⑦ ⑧

- ① Series No.
- ② Category: H-HSG
- ③ Connector type: M-Male HSG
- ④ Row No.-Pin No Per Row: 2*XX-2*01P~2*12P
- ⑤ Material: N0-PA66 94V-0
- ⑥ HF-Halogen Free Blank-RoHS
- ⑦ Color: Blank-Black
- ⑧ Plug the Pin & Special No.: Blank- Ordinary



2*1PIN

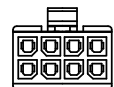

2*4PIN

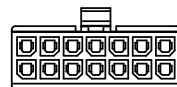

2*7PIN

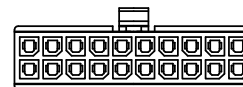

2*10PIN



2*2PIN

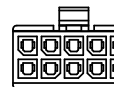

2*5PIN

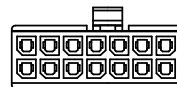

2*8PIN

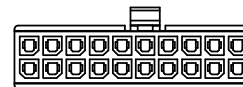

2*11PIN



2*3PIN

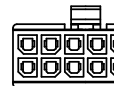

2*6PIN

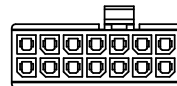

2*9PIN

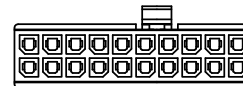

2*12PIN



| Poles | Dimensions(mm) | | Poles | Dimensions(mm) | |
|-------|----------------|-------|-------|----------------|-------|
| | A | B | | A | B |
| 2*01 | / | / | 2*07 | 18.00 | 21.85 |
| 2*02 | 3.00 | / | 2*08 | 21.00 | 24.85 |
| 2*03 | 6.00 | 9.85 | 2*09 | 24.00 | 27.85 |
| 2*04 | 9.00 | 12.85 | 2*10 | 27.00 | 30.85 |
| 2*05 | 12.00 | 15.85 | 2*11 | 30.00 | 33.85 |
| 2*06 | 15.00 | 18.85 | 2*12 | 33.00 | 36.85 |

| | | | | | | | | | | | | | | | |
|------|-----|---------|-------------|--------|-------------------|---------|---|------|-------|------------|--|-------|-------|-------|--------|
| | | | | | GENERAL TOLERANCE | | 东莞市国亚电子有限公司 DONGGUO GUOYA ELECTRONICS CO.,LTD | | | | PART NO. 3025HM-2*XX-N0XX-00 | | | | |
| | | | | | .X ±0.30 | | | | | | TITLE 3.00mm Crimp Style Connectors | | | | |
| | | | | | .XX ±0.20 | | | | | | | | | | |
| | | | | | .XXX ±0.10 | | | | | | | | | | |
| | | | | | X.° ±2° | | APPROVAL | | CHECK | DRAWN | DATE | UNIT | | | |
| DATE | REV | ECN NO. | DESCRIPTION | MODIFY | APPROVAL | PROJECT | YANG | TIAN | TIAN | 2018/03/15 | mm | SCALE | SHEET | REV | NUMBER |
| 1 | 2 | | | 4 | | | | | | | 1:1 | 1/1 | A0 | A-000 | |

RoHS

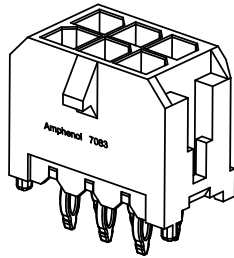
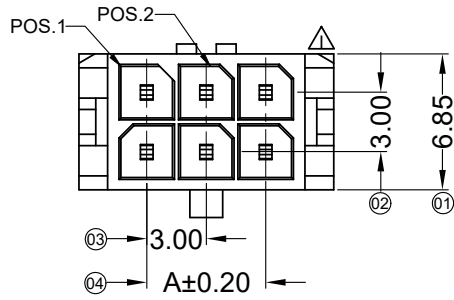

■ Specifications :

- Voltage rating: 250V AC / DC
- Current rating: 5A AC / DC
- Withstanding voltage: 1000V AC/minute
- Temperature range: -40°C~+105°C
- Insulation resistance: ≥1000MΩ
- Contact resistance: ≤10mΩ
- After environmental testing: ≤20mΩ
- Material(Pin&Solder tab): Phosphor Bronze
- Mates With GYA Housing 3025H-2*XX

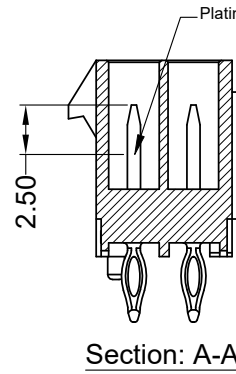
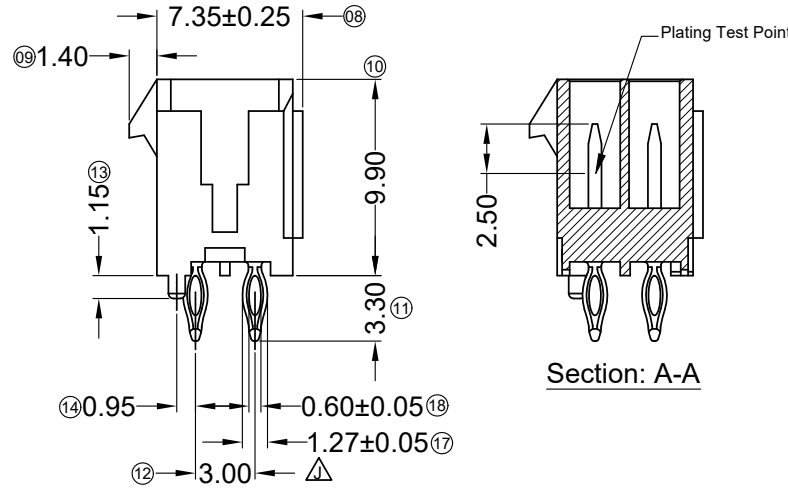
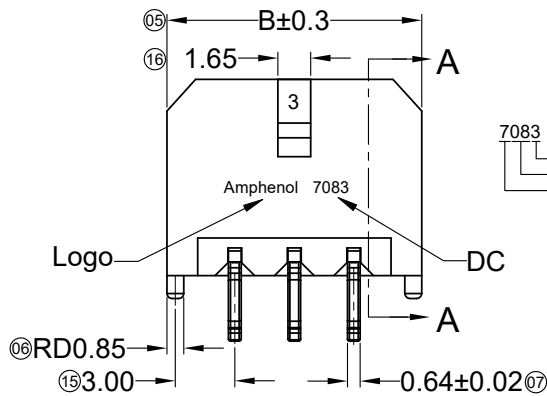

3025 W V X-2*XX CE -LP XX XX-XX
 ① ② ③ ④ ⑤ ⑥ ⑦ ⑧ ⑨ ⑩

- ① Series No.
- ② Category: W-WAFER
- ③ Connector Type: V-Straight 180°
- ④ Mounting Type: Blank-DIP
- ⑤ Row No.-Pin No.: 2*XX-2*01P~2*22P
- ⑥ Special No.: CE-Press-fit Type
- ⑦ Material: LP-LCP 94V-0
- ⑧ Plating Category:
 SW-Matte Tin Plating 100u" Min.
 G15-Contact Area Gold 15u"Min.;Solder Area 100u" Min.
 G30-Contact Area Gold 30u"Min.;Solder Area 100u" Min.
 Ni: 50u" Min
- ⑨ Color : Blank- Black Color
- ⑩ DC-With Date Code Blank-No Date Code

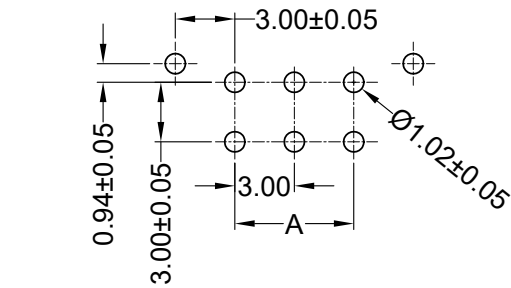

Recommended P.C.B Layout

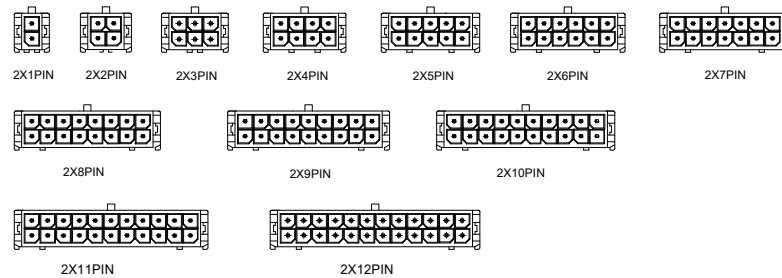

| Poles | Dimensions (mm) | | Poles | Dimensions (mm) | |
|-------|-----------------|-------|-------|-----------------|-------|
| | A | B | | A | B |
| 2*01 | --- | 6.85 | 2*07 | 18.00 | 24.85 |
| 2*02 | 3.00 | 9.85 | 2*08 | 21.00 | 27.85 |
| 2*03 | 6.00 | 12.85 | 2*09 | 24.00 | 30.85 |
| 2*04 | 9.00 | 15.85 | 2*10 | 27.00 | 33.85 |
| 2*05 | 12.00 | 18.85 | 2*11 | 30.00 | 36.85 |
| 2*06 | 15.00 | 21.85 | 2*12 | 33.00 | 39.85 |

| | | | | | | | | | | | | | | | | | | | | | |
|------|-----|---------|-------------|--------|---|--|--|--|--|------|-------|-------|-------------------------------------|--------|--|--|---------------------------------------|--|--|--|--|
| | | | | | GENERAL TOLERANCE .X ±0.30 .XX ±0.20 .XXX ±0.10 X.° ±2° | | | | 东莞市国亚电子有限公司 DONGGUO GUOYA ELECTRONICS CO.,LTD | | | | PART NO. 3025WV-2*XXCE-LPXXXX-XX | | | | | | | | |
| | | | | | APPROVAL YANG | | | | CHECK TIAN | | | | DRAWN TIAN | | | | DATE 2017/02/27 | | | | |
| | | | | | PROJECT | | | | | | | | | | | | TITLE 3.00mm Crimp Style Connector | | | | |
| DATE | REV | ECN NO. | DESCRIPTION | MODIFY | APPROVAL | | | | | UNIT | SCALE | SHEET | REV | NUMBER | | | | | | | |
| | | | | | | | | | | mm | 1:1 | 1/1 | A0 | A-000 | | | | | | | |