

RoHS

■ Specifications :

- Voltage rating: 250V AC / DC
- Current rating: 5A Max AC / DC
- Withstanding voltage: 1000V AC/minute
- Temperature range: -40°C~+105°C
- Insulation resistance: ≥1000MΩ
- Contact resistance: ≤10mΩ
- After environmental testing: ≤20mΩ
- Suitable GYA Terminal: 3025TM
- Female With GYA Mate HSG: 3025HM

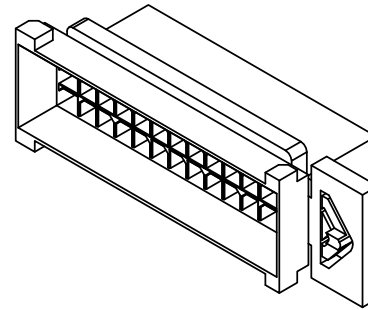

3025 H F - 2xXX - N0 B B R 01 F

① ② ③ ④ ⑤ ⑥ ⑦ ⑧ ⑨ ⑩

- ① Series No.
- ② Category: H-HSG
- ③ Connector Type: F-Female HSG
- ④ Row No.-Pin No.: 2xXX-Double Row
- ⑤ Material: N0-PA66 94V-0
- ⑥ Color: B- Black
- ⑦ Packing: B-Bag
- ⑧ RoHS/HF: R-Rohs
- ⑨ Sequence Number: 01
- ⑩ Special code: F-Other Connectors

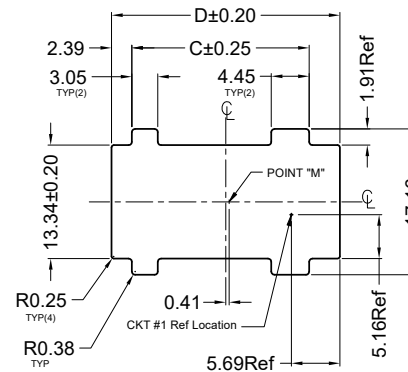
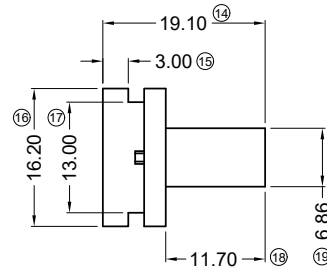
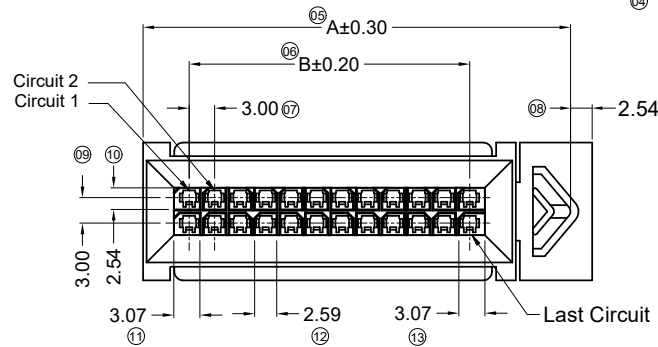
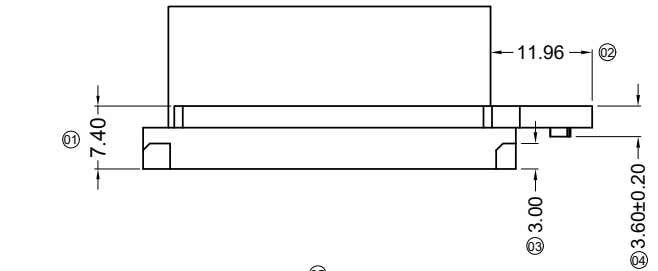

RECOMMENDED PANEL CUT-OUT
THICK:1.27mmMin / 1.57mmMax

When mating with 3025HF series,Point"M" must align with the panel cut-out centerlines defined by SWB drawing 3025HF-2xXX-N0BBR01F

Poles	Dimensions(mm)				Poles	Dimensions(mm)			
	A	B	C	D		A	B	C	D
2*01	/	/	/	/	2*07	35.3	18.00	29.85	35.85
2*02	20.3	3.00	14.85	20.85	2*08	38.3	21.00	32.85	38.85
2*03	23.3	6.00	17.85	23.85	2*09	41.3	24.00	35.85	41.85
2*04	26.3	9.00	20.85	26.85	2*10	44.3	27.00	38.85	44.85
2*05	29.3	12.00	23.85	29.85	2*11	47.3	30.00	41.85	47.85
2*06	32.3	15.00	26.85	32.85	2*12	50.3	33.00	44.85	50.85

GENERAL TOLERANCE

- .X ±0.30
- .XX ±0.20
- .XXX ±0.10
- X.° ±2°



东莞市国亚电子有限公司
DONGGUO GUOYA ELECTRONICS CO.,LTD

PART NO.

3025HF-2xXX-N0BBR01F

TITLE

MICRO FIT 3.0mm DUAL ROW
FEMALE HOUSING

APPROVAL

CHECK

DRAWN

DATE

UNIT SCALE SHEET REV NUMBER

mm 1:1 1/2 A0 A-000

PROJECT

YANG

TIAN

TIAN

2018/09/06

DATE REV ECN NO. DESCRIPTION MODIFY APPROVAL

1 2 3 4 5 6 7 8

RoHS

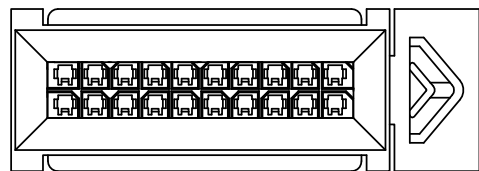

2x10

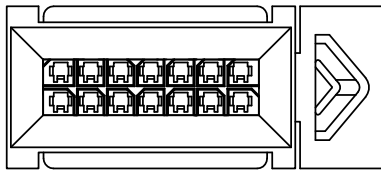

2x7

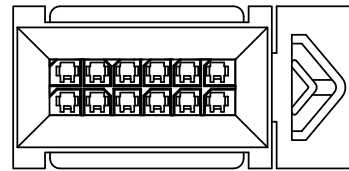

2x6

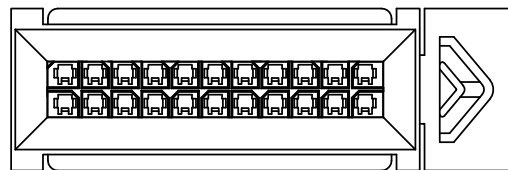

2x11

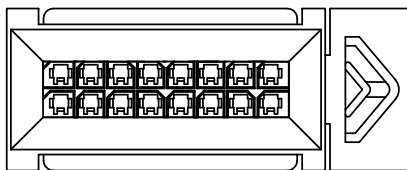

2x8

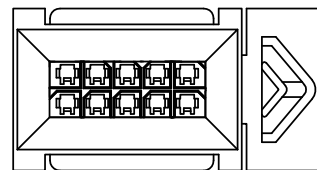

2x5

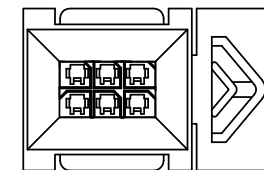

2x3

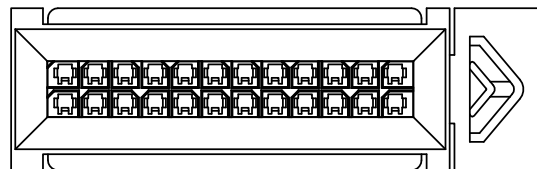

2x12

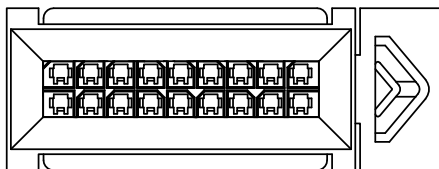

2x9

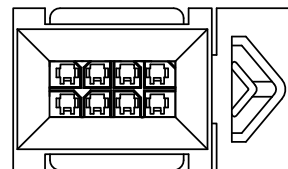

2x4

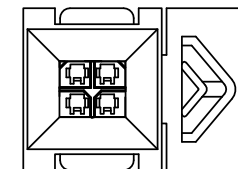

2x2

					GENERAL TOLERANCE .X ±0.30 .XX ±0.20 .XXX ±0.10 X.° ±2°		东莞市国亚电子有限公司 DONGGUO GUOYA ELECTRONICS CO.,LTD		PART NO. 3025HF-2xxx-N0BBR01F			
					PROJECT 		APPROVAL YANG	CHECK TIAN	DRAWN TIAN	DATE 2018/09/06	TITLE MICRO FIT 3.0mm DUAL ROW FEMALE HOUSING	
DATE	REV	ECN NO.	DESCRIPTION	MODIFY	APPROVAL	UNIT	SCALE	SHEET	REV	NUMBER		
						mm	1:1	2/2	A0	A-000		

RoHS

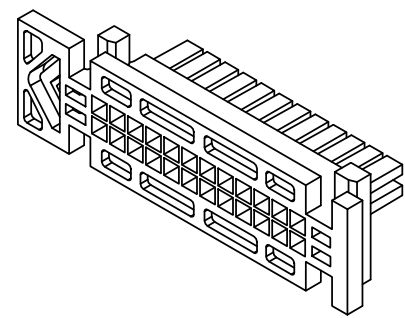
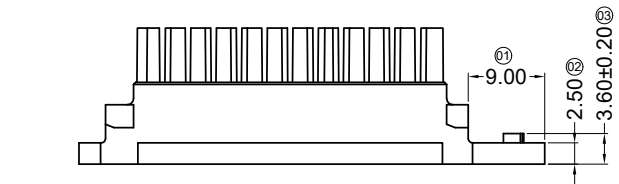

- Specifications :
- Voltage rating: 250V AC / DC
 - Current rating: 5A Max AC / DC
 - Withstanding voltage: 1000V AC/minute
 - Temperature range: -40°C~+105°C
 - Insulation resistance: ≥1000MΩ
 - Contact resistance: ≤10mΩ
 - After environmental testing: ≤20mΩ
 - Suitable GYA Terminal:3025TF
 - Mate With GYA Female HSG :3025HF

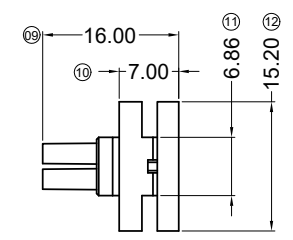
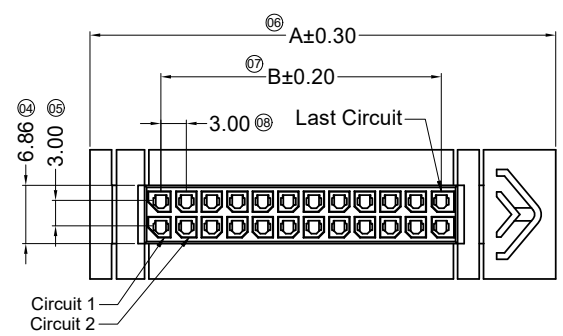

3025 H M - 2xXX - N0 B B R 01 F
 ① ② ③ ④ ⑤ ⑥ ⑦ ⑧ ⑨ ⑩

- ① Series No.
- ② Category: H-HSG
- ③ Connector Type: M-Male HSG
- ④ Row No.-Pin No.: 2xXX-Double Row
- ⑤ Material: N0-PA66 94V-0
- ⑥ Color: B- Black
- ⑦ Packing: B-Bag
- ⑧ RoHS/HF: R-Rohs
- ⑨ Sequence Number: 01
- ⑩ Special code : F-Other Connectors

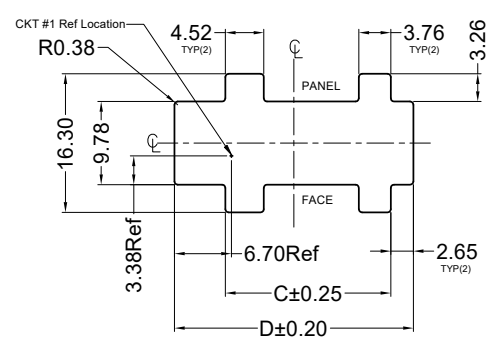
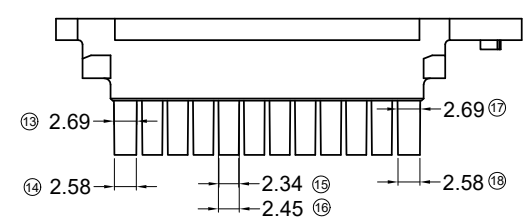

RECOMMENDED PANEL CUT-OUT THICK:1.27mmMin / 1.57mmMax

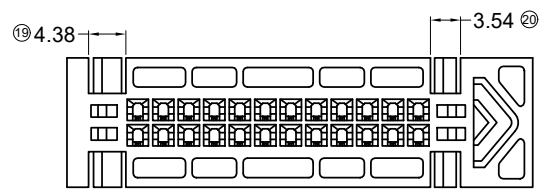

Poles	Dimensions(mm)				Poles	Dimensions(mm)			
	A	B	C	D		A	B	C	D
2*01	/	/	/	/	2*07	39.8	18.00	28.46	37.10
2*02	24.6	3.00	13.46	22.10	2*08	42.8	21.00	31.46	40.10
2*03	27.7	6.00	16.46	25.10	2*09	45.8	24.00	34.46	43.10
2*04	30.7	9.00	19.46	28.10	2*10	48.8	27.00	37.46	46.10
2*05	33.8	12.00	22.46	31.10	2*11	51.8	30.00	40.46	49.10
2*06	36.8	15.00	25.46	34.10	2*12	54.8	33.00	43.46	52.10

DATE	REV	ECN NO.	DESCRIPTION	MODIFY	APPROVAL

GENERAL TOLERANCE
 .X ±0.30
 .XX ±0.20
 .XXX ±0.10
 X.° ±2°

PROJECT

APPROVAL: YANG
 CHECK: TIAN
 DRAWN: TIAN
 DATE: 2019/07/15

GYA 东莞市国亚电子有限公司
 DONGGUO GUOYA ELECTRONICS CO.,LTD

PART NO. 3025HM-2xxx-N0BBR01F

TITLE MICRO FIT 3.0mm DUAL ROW PLUG HOUSING

UNIT	SCALE	SHEET	REV	NUMBER
mm	1:1	1/2	A0	A-000

RoHS

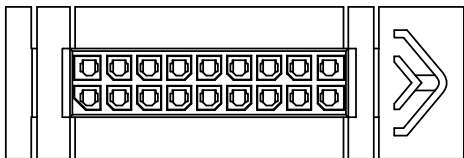

2x9

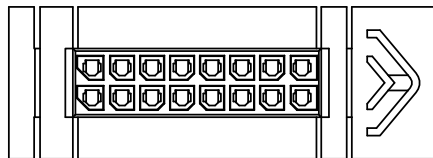

2x8

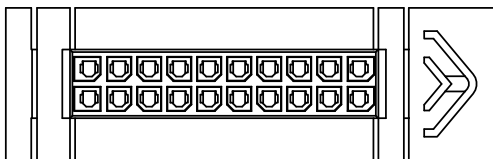

2x10

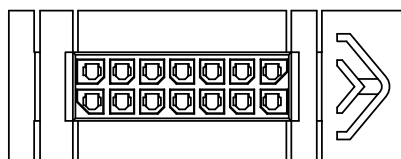

2x7

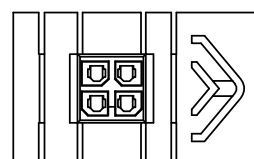

2x2

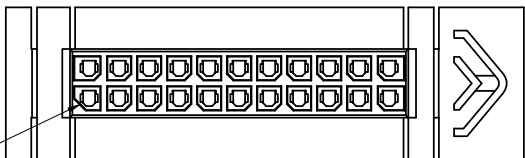

2x11

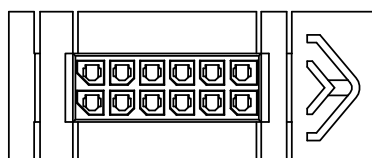

2x6

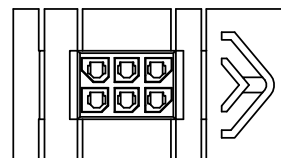

2x3

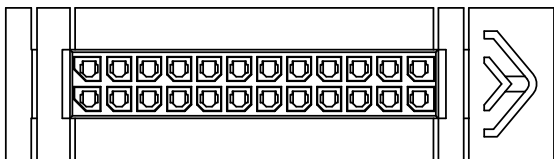

2x12

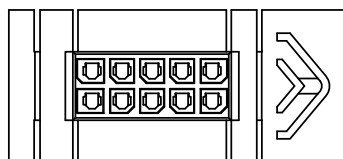

2x5

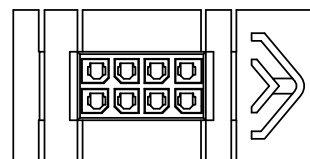

2x4

					GENERAL TOLERANCE .X ±0.30 .XX ±0.20 .XXX ±0.10 X.° ±2°		东莞市国亚电子有限公司 DONGGUO GUOYA ELECTRONICS CO.,LTD		PART NO. 3025HM-2XXX-N0BBR01F		
					PROJECT 		APPROVAL YANG	CHECK TIAN	DRAWN TIAN	DATE 2019/07/15	TITLE MICRO FIT 3.0mm DUAL ROW PLUG HOUSING
DATE	REV	ECN NO.	DESCRIPTION	MODIFY	APPROVAL	UNIT	SCALE	SHEET	REV	NUMBER	
1		2		4		mm	1:1	2/2	A0	A-000	

RoHS

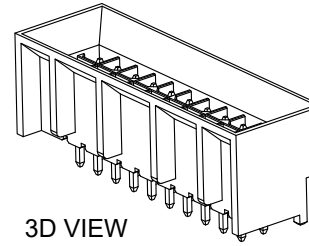
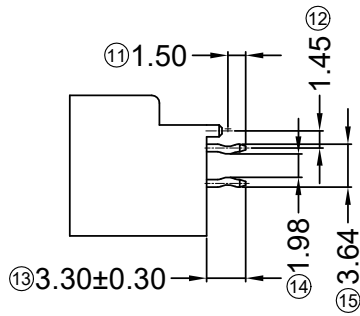
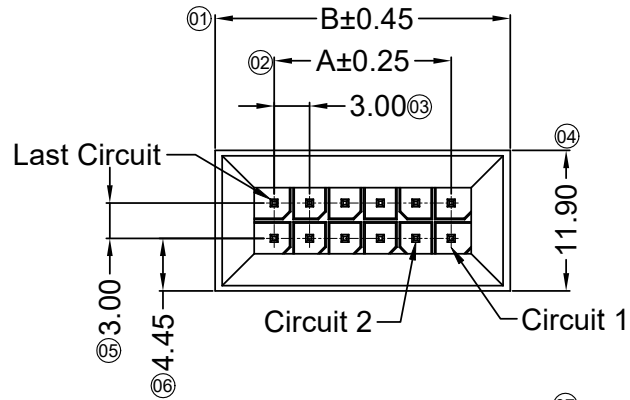

3D VIEW

■ Specifications :

- Voltage rating: 250V AC / DC
- Current rating: 5A AC / DC
- Withstanding voltage: 1000V AC/minute
- Temperature range: -25°C~+85°C
- Insulation resistance: ≥1000MΩ
- Contact resistance: ≤20mΩ
- After environmental testing: ≤30mΩ
- Material(Pin): Brass
- Mates With GYA Housing 3025H

3025 W V X- 2*XX P - 9T XX XX
 ① ② ③ ④ ⑤ ⑥ ⑦ ⑧ ⑨

- ① Series No.
- ② Category: W-wafer
- ③ Connector Type: V-180°
- ④ Mounting Type: Blank-DIP
- ⑤ Row No.-Pin No.: 2*XX-Double row
- ⑥ Special NO.: P-With Post
- ⑦ Material: 9T-PA9T 94V-0
- ⑧ Plating Category:
 SW1-Matte Tin 100u" Min; Ni 50u" Min.
 V01- Au Gold Flash ; Ni 50u" Min.
- ⑨ Color: Blank- Black Color

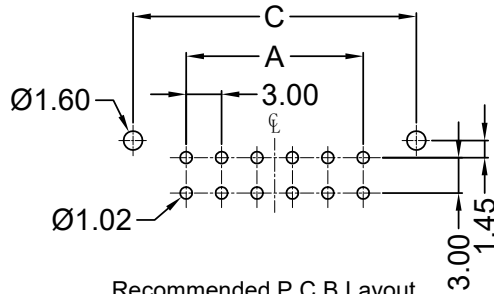
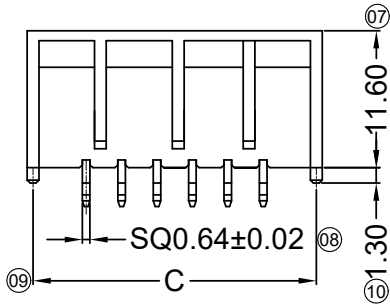

Recommended P.C.B Layout
 General Tolerance±0.05

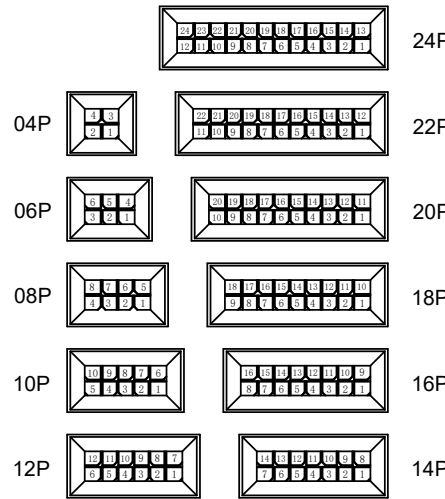

Part No.	Dimensions (mm)		
	A	B	C
2x02	3.00	13.00	12.00
2x03	6.00	16.00	15.00
2x04	9.00	19.00	18.00
2x05	12.00	22.00	21.00
2x06	15.00	25.00	24.00
2x07	18.00	28.00	27.00
2x08	21.00	31.00	30.00
2x09	24.00	34.00	33.00
2x10	27.00	37.00	36.00
2x11	30.00	40.00	39.00
2x12	33.00	43.00	42.00

					GENERAL TOLERANCE .X ±0.30 .XX ±0.20 .XXX ±0.10 X.° ±2°				东莞市国亚电子有限公司 DONGGUO GUOYA ELECTRONICS CO.,LTD				PART NO. 3025WV-2*XXP-9TXXXX								
					APPROVAL YANG				CHECK TIAN				DRAWN TIAN				DATE 2019/11/02				
					PROJECT 												TITLE 3.00mm Crimp Style Connectors				
DATE	REV	ECN NO.	DESCRIPTION	MODIFY	APPROVAL					UNIT	SCALE	SHEET	REV	NUMBER							
1		2		4						mm	1:1	1/1	A0	A-007							

