

RoHS

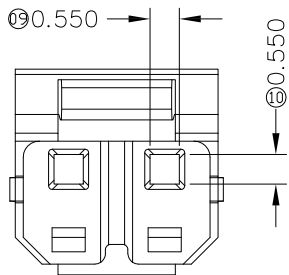
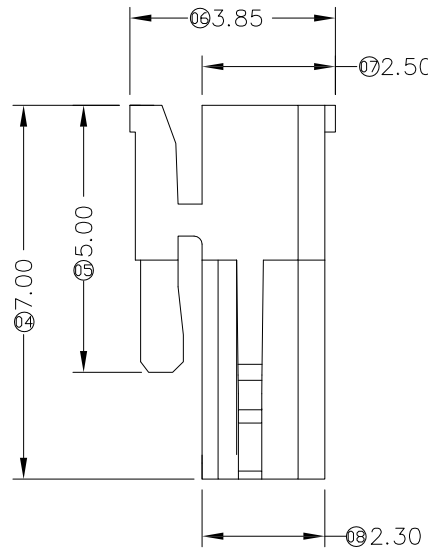
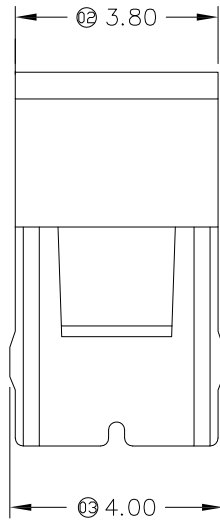
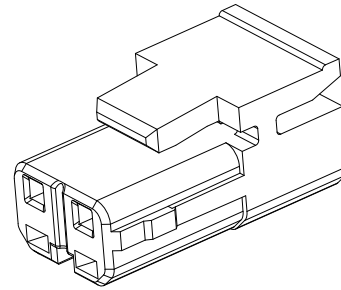
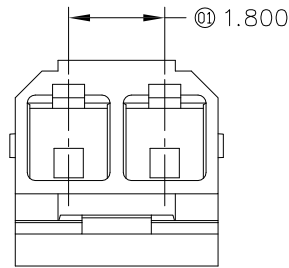

■ Specifications :

- Voltage rating: 350V AC / DC
- Current rating: 3.2A AC / DC
- Withstanding voltage: 1700V AC/minute
- Temperature range: -40° ~+105°
- Insulation resistance: ≥1000MΩ
- Contact resistance: ≤10mΩ
- After environmental testing: ≤20mΩ

- Suitable GYA Terminal: 1800TX-PSN-A
- Suitable GYA Wafer: 1800WRS-02A
- Suitable GYA Female Housing: 1804HF-1x02

1800 H X-02 A-N0 HF XX

① ② ③ ④ ⑤ ⑥ ⑦ ⑧

- ① Series No.
- ② Category: H-HSG
- ③ Welding Board Angle: Blank-ordinary
- ④ Row No.-Pin No.: 02-02P
- ⑤ Special No.: A-With Lock
- ⑥ Material: N0-PA66 94V-0
- ⑦ HF-Halogen free
- ⑧ None-Natural Color ; BK-Black Color



					GENERAL TOLERANCE		GYA 东莞市国亚电子有限公司 Connectors Dong Guan Guo Ya Connectors co., Ltd.			PART NO. 1800H-02A-N0HFXX						
					.X ±0.30					TITLE 1.80mm Crimp Style Connectors						
					.XX ±0.20		APPROVAL		CHECK						DRAWN	
					.XXX ±0.10		Yangzhengguo		Yangzhengyi		Lviansheng		2016/08/26			
					X.° ±2°		PROJECT									
DATE	REV	ECN NO.	DESCRIPTION	MODIFY	APPROVAL							UNIT	SCALE	SHEET	REV	NUMBER
1												mm	1:1	1/1	A0	A-022

RoHS

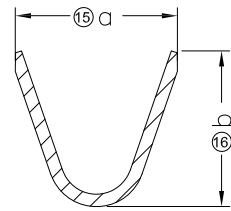
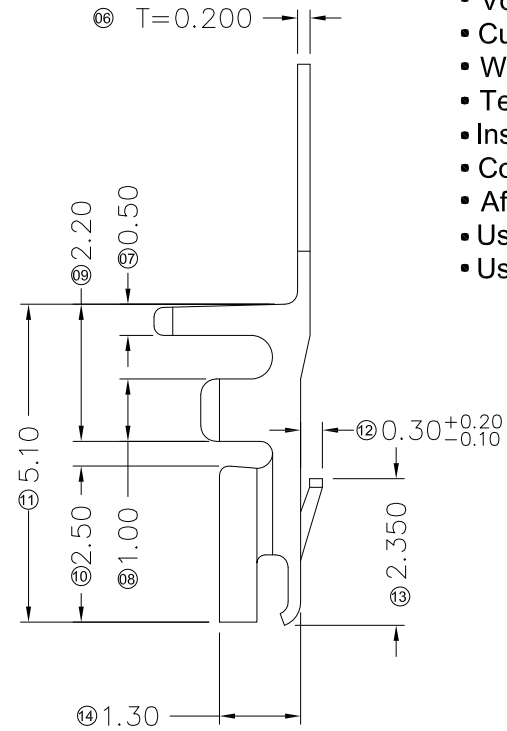
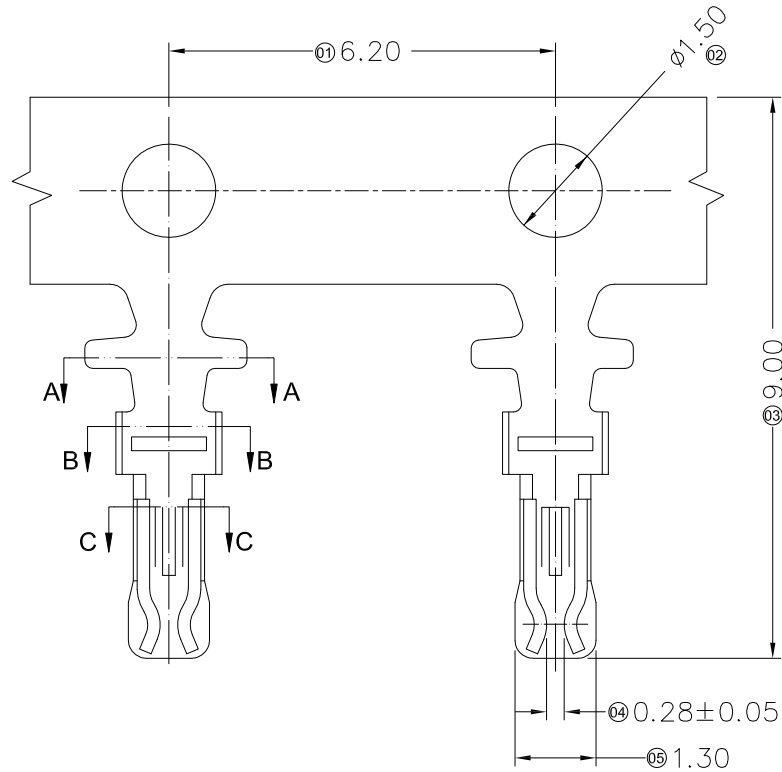

SECTION A-A
SCALE 1:1

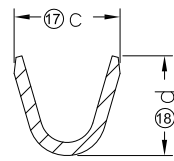

SECTION B-B
SCALE 1:1

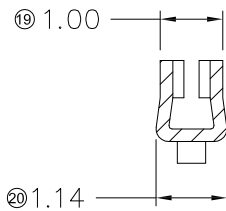

SECTION C-C
SCALE 1:1



Specifications :

- Voltage rating: 350V AC / DC
- Current rating: 3.2A AC / DC
- Withstanding voltage: 1700V AC/minute
- Temperature range: -40° ~+105°
- Insulation resistance: ≥1000MΩ
- Contact resistance: ≤10mΩ
- After environmental testing: ≤20mΩ
- Used In GYA Housing: 1800H-02/1800H-02A
- Used In GYA Wafer: 1800WRS-02/1800WRS-02A

1800 T X- P SN X- A
① ② ③ ④ ⑤ ⑥ ⑦

- ① Series Number
- ② Category: T-terminal
- ③ Shape: Blank-ordinary; L-Lower
- ④ Material: P-Phosphor bronze
- ⑤ Plating Style: SN-Bright tin plating
- ⑥ Plating Method :
Blank-Stamping before Plating
- ⑦ A-A TYPE

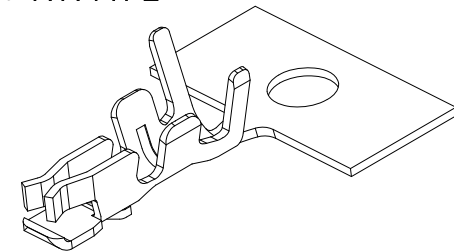

1800T-PSN-A	AWG#22-26 (0.35~0.13mm ²)	0.95-1.30mm	2.6	2.5	1.7	1.6	
1800TL-PSN-A	AWG#26-28	0.95 Max.	1.9	1.9	1.20	1.20	
PART NO	Wire Size	Insulation	O.D.	DIM a	DIM b	DIM c	DIM d

DATE	REV	ECN NO.	DESCRIPTION	MODIFY	APPROVAL
1		2		4	

GENERAL TOLERANCE	
.X	±0.30
.XX	±0.20
.XXX	±0.10
X.°	±2°
PROJECT	
⊕	⊖

GYA 东莞市国亚电子有限公司
Connectors Dong Guan Guo Ya Connectors co., Ltd.

APPROVAL	CHECK	DRAWN	DATE
Yangzhengguo	Yangzhengyi	Lvliansheng	2016/08/26

PART NO. 1800TX-PSN-A				
TITLE 1.80mm Crimp Style Connectors				
UNIT	SCALE	SHEET	REV	NUMBER
mm	1:1	1/1	A0	A-000

RoHS

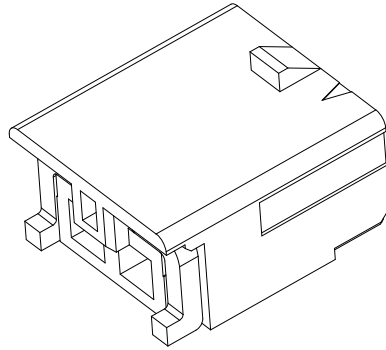
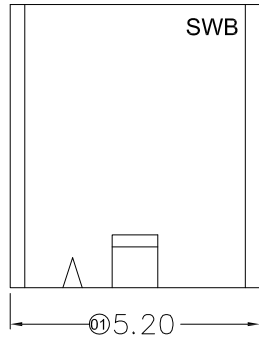

Specifications :

- Voltage rating: 350V AC / DC
- Current rating: 3.2A AC / DC
- Withstanding voltage: 1700V AC/minute
- Temperature range: -40° ~+105°
- Insulation resistance: ≥1000MΩ
- Contact resistance: ≤10mΩ
- After environmental testing: ≤20mΩ
- Material(Pin&Solder tab):Brass
- Mates With GYA Housing:1800H-02A

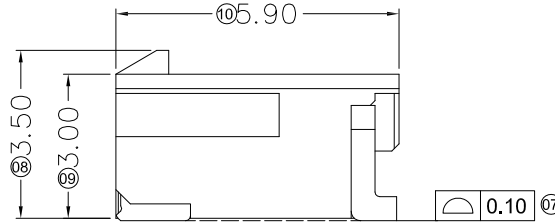
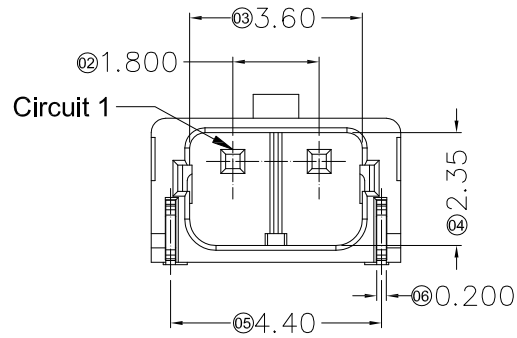

1800 W R S-02 A -LP SW XX - X
 ① ② ③ ④ ⑤ ⑥ ⑦ ⑧ ⑨ ⑩

- ① Series No.
- ② Category: W-WAFER
- ③ Connector Type: R-Right Angle 90°
- ④ Welding Way: S-SMT
- ⑤ Row No.-Pin No.: 02-02P
- ⑥ Plug the Pin & Special No.: A-With Lock
- ⑦ Material: LP -LCP 94V-0
- ⑧ Plating Category: SW-Matte Tin Plating
- ⑨ Color : Blank-Natural Color
- ⑩ Special code: A-Package reverse
Blank-ordinary

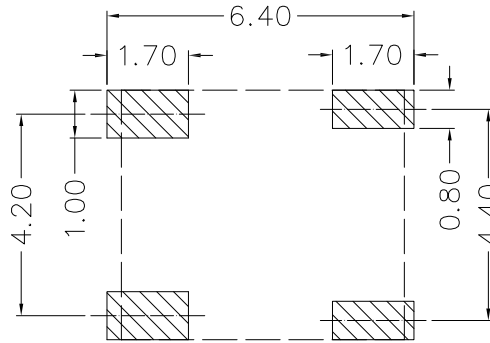
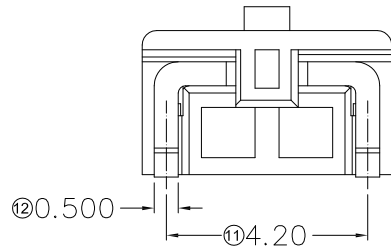

Recommended P.C.B Layout
 General Tolerance±0.05



					GENERAL TOLERANCE .X ±0.30 .XX ±0.20 .XXX ±0.10 X.° ±2°				GYA 东莞市国亚电子有限公司 Connectors Dong Guan Guo Ya Connectors co., Ltd.				PART NO. 1800WRS-02A-LPSW-X			
					PROJECT 				APPROVAL Yangzhengguo Yangzhengyi Lviliansheng 2016/08/26				TITLE 1.80mm Crimp Style Connectors			
DATE	REV	ECN NO.	DESCRIPTION	MODIFY	APPROVAL							UNIT	SCALE	SHEET	REV	NUMBER
1												mm	1:1	1/1	A0	A-000