

RoHS

包装图

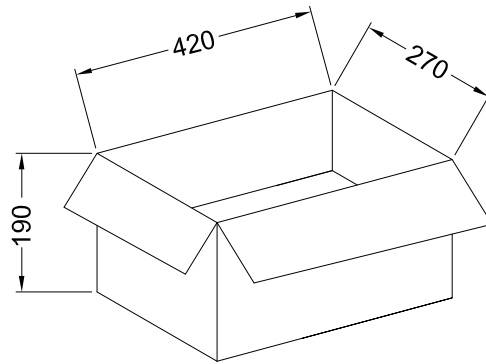

胶带ADHESIVE TAPE

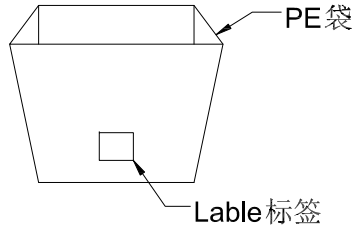
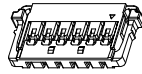
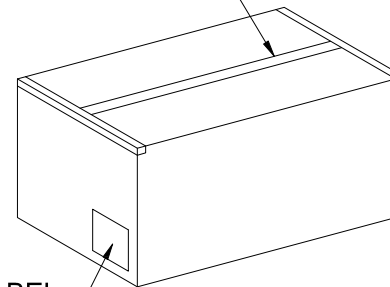

Note注解:

1. Put Housing in a PE bag, PE bag gauge for: 130 * 135 * 0.10 mm, Packing detail see the table below

将 Housing放入PE袋内, PE袋规为: 130*135*0.10mm, 详细包装见下表

2. Put PE bag packed products in specifications of 420 * 270 * 190 mm cartons, Packing detail see the table below

将装好产品的PE袋放入规格为420*270*190mm的纸箱内, 详细包装见下表

3. Label depends on customer request, carton opening joint with transparent tape

标签依客户要求而定, 纸箱开口处用透明胶带贴合.



Poles	Bag PCS	CARTON Bag	CARTON PCS
02	1000	65	65K
03	1000	60	60K
04	1000	60	60K
05	1000	55	55K
06	1000	55	55K
07	1000	50	50K
08	1000	50	50K
09	1000	45	45K
10	1000	45	45K
11	1000	40	40K
12	1000	40	40K

DATE	REV	ECN NO.	DESCRIPTION	MODIFY	APPROVAL	GENERAL TOLERANCE	APPROVAL CHECK DRAWN DATE				PART NO.: 1503H-XX-XX					
						.X ±0.35	GYA 东莞市国亚电子有限公司 Connectors Dong Guan Guo Ya Connectors co., Ltd.	Yangzhengguo	Yangzhengyi	Lvtiansheng	2016/08/26	TITLE: 1.50mm Housing Package				
					.XX ±0.25	UNIT						SCALE	SHEET	REV	NUMBER	
					.XXX ±0.15	mm						1:1	1/1	A0	A-000	
					X.° ±0.2°											

GENERAL TOLERANCE

.X ±0.35

.XX ±0.25

.XXX ±0.15

X.° ±0.2°



东莞市国亚电子有限公司
Dong Guan Guo Ya Connectors co., Ltd.

PART NO.: 1503H-XX-XX

TITLE: 1.50mm Housing Package

UNIT	SCALE	SHEET	REV	NUMBER
mm	1:1	1/1	A0	A-000

RoHS

包装图

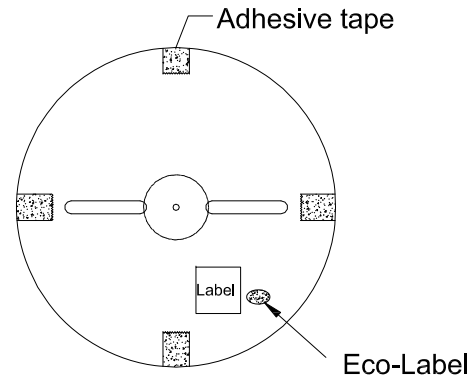

Note注解:

1.Quantity 数量:

10K PCS/REEL 一卷10K/PCS

10 REEL/BOX 一箱10卷

100K PCS/BOX 一箱100K/PCS

2.Each reel and outer box must be labeled and Eco-Label Respectively labeled

每盘和外箱都必须有标签及环保标签分别标示

3.Terminal winding direction as shown

端子缠绕方向如左图所示

4.There shall be no dirt such as deformation phenomenon, Mantissa box fillers must be used

每箱不可有脏污, 变形现象, 尾数箱必须用填充物

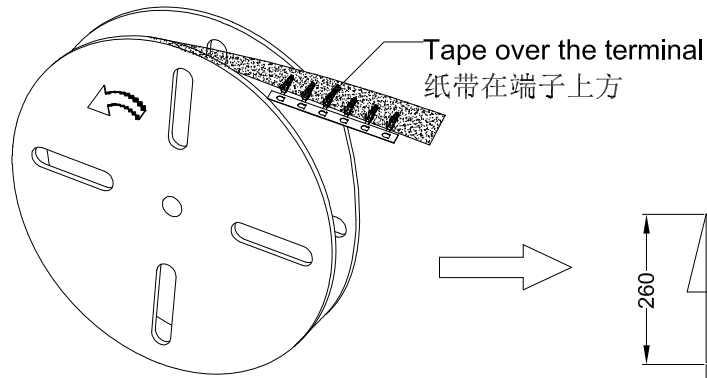

卷装方式
Package way

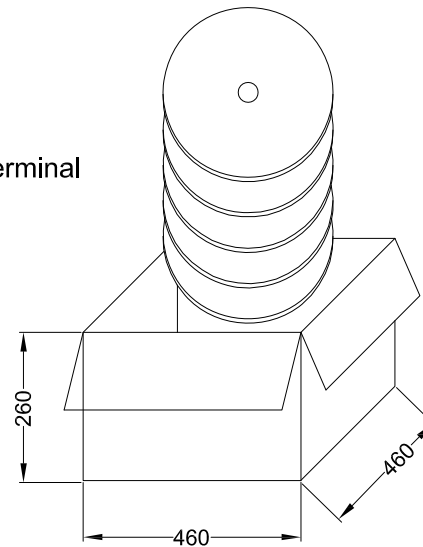

Adhesive tape 胶带

Label unified on the box top right corner
外箱标签位于右上角

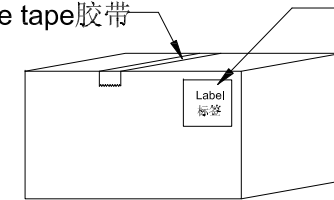

				GENERAL TOLERANCE		PART NO.: 1503T-XXX			
				.X ±0.35		TITLE: 1.50mm Terminal Packing			
				.XX ±0.25		UNIT SCALE SHEET REV NUMBER			
				.XXX ±0.15		mm 1:1 1/1 A0 A-159			
				X° ±0.2°		APPROVAL CHECK DRAWN DATE			
				视 角		Yangzhengguo Yangzhengyi Lvtiansheng 2016/08/26			
DATE	REV	ECN NO.	DESCRIPTION	MODIFY	APPROVAL	GYA 东莞市国亚电子有限公司 Connectors Dong Guan Guo Ya Connectors co., Ltd.			

RoHS 包装图

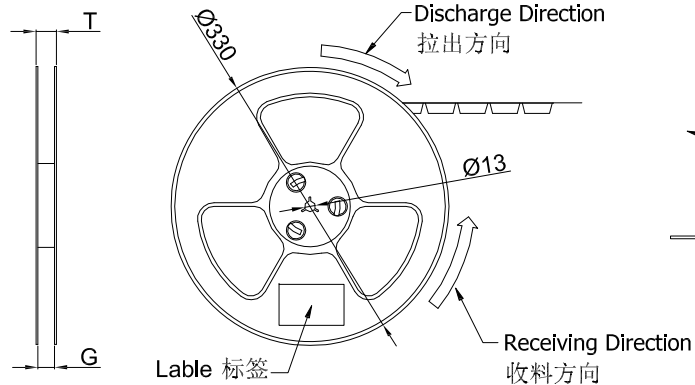
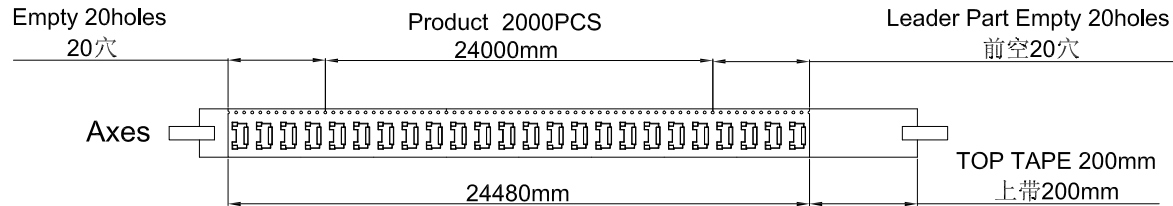

COVER TAPE PEEL STRENGTH:20~120g
上带剥离力量: 20~120g
速度 PEEL SPEED:300mm/minute

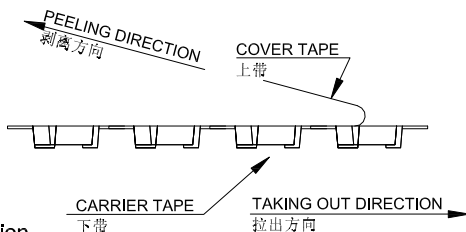

Lable 标签
Single hole: None Hole Side
单孔: 贴无链孔侧
Double hole: Elliptical Hole Side
双孔: 贴椭圆孔侧

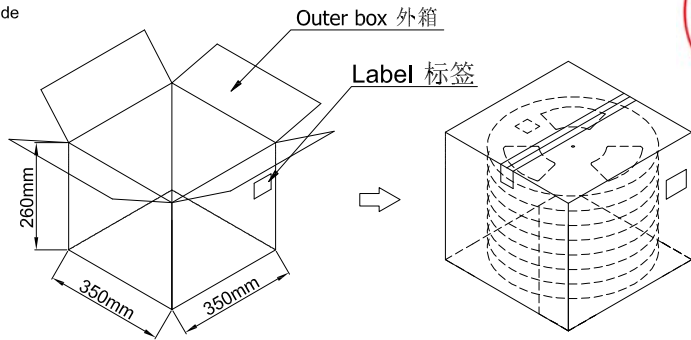
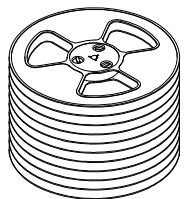

- Note:
- Carrier Camber Is Within 1mm In 250mm; 带长250mm 内容许弯曲度1mm
 - 10 Sprocket Hole Pitch Cumulative Tolerance±0.2MM; 圆孔十个孔距离累计允许公差为±0.2mm
 - Carrier tape material for PS; 下带材质为PS材质; Color 颜色:Natural 透明色, 无齿
 - bracer保护带; Color 颜色:Natural 透明色, 厚度0.40mm 最小
 - Thickness=0.30±0.05; 材料厚度为0.30±0.05mm
 - Carton material 纸箱材质:K=K; Carton Thickness 纸箱厚度: 6~7mm

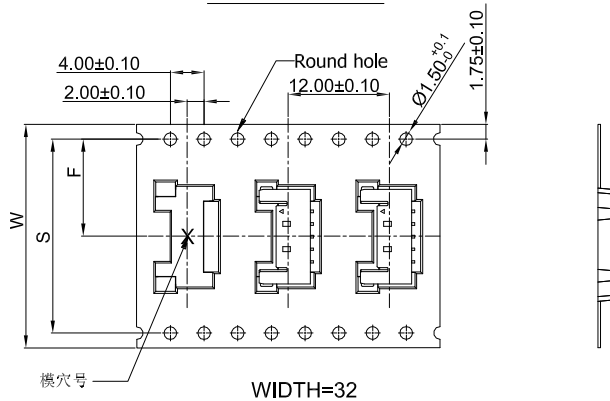
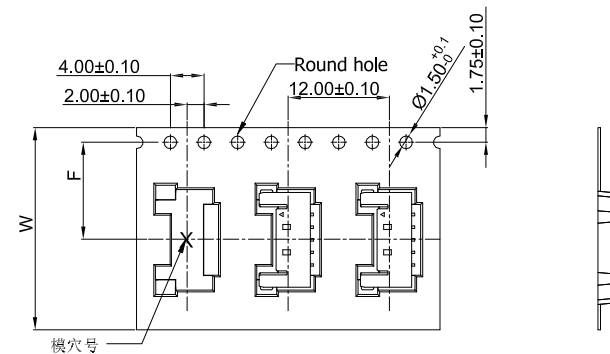

Pin No.	W	S	F	T	G	Cover Tape(宽度) 上带(W)	Carrier Tape(Color) 下带(颜色)	REEL /PCS	CARTON /R	CARTON /PCS
ZD1503WRS-02HF	16	-	7.50	20.50	16.50	11.3	透明色	2000	11R	22000
ZD1503WRS-03HF										
ZD1503WRS-04HF										
ZD1503WRS-05HF										
ZD1503WRS-06HF	24	-	11.50	28.50	24.50	21.3	透明色	2000	8R	16000
ZD1503WRS-07HF										
ZD1503WRS-08HF	32	28.4	14.20	36.50	32.50	25.5	透明色	2000	6R	12000
ZD1503WRS-09HF										
ZD1503WRS-10HF										
ZD1503WRS-11HF										
ZD1503WRS-12HF										

DATE	REV	ECN NO.	DESCRIPTION	MODIFY	APPROVAL

GENERAL TOLERANCE

.X	±0.35
.XX	±0.25
.XXX	±0.15
X.°	±0.2°

視角

GYA 东莞市国亚电子有限公司
Connectors Dong Guan Guo Ya Connectors co., Ltd.

APPROVAL	CHECK	DRAWN	DATE
Yangzhengguo	Yangzhengyi	Lvtiansheng	2016/08/26

PART NO.: PPN: 1503WRS-XX-XXXX
CTN: ZD1503WRS-XXHF

TITLE: 1.50mm SMT 90° Package

UNIT	SCALE	SHEET	REV	NUMBER
mm	1:1	1/1	A0	A-159