

RoHS

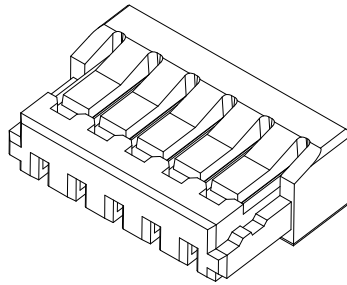

■ Specifications :

- Voltage rating: 30V AC / DC
- Current rating: 0.50A AC / DC
- Withstanding voltage: 200V AC/minute
- Temperature range: -40° ~+105°
- Insulation resistance: ≥100MΩ
- Contact resistance: ≤20mΩ
- After environmental testing: ≤40mΩ
- Suitable GYA Terminal: 0800T
- Mates With GYA Wafer: 0800W

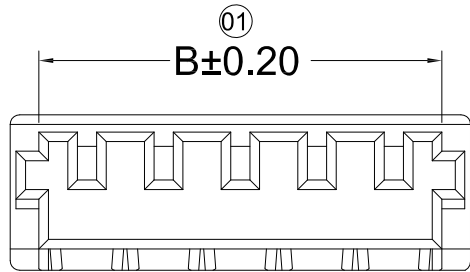
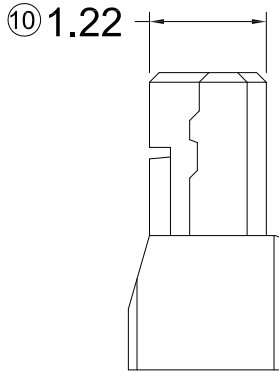
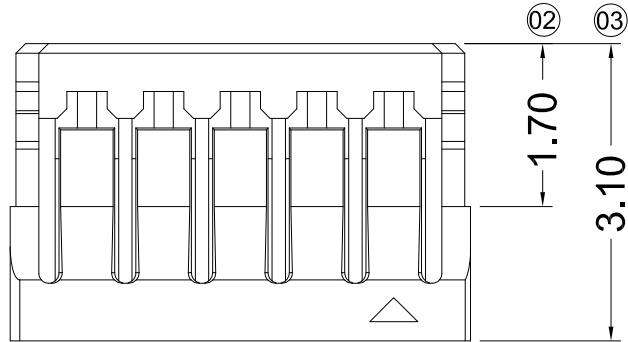

0800 H X - XX X - 46 XX
 ① ② ③ ④ ⑤ ⑥ ⑦

- ① Series No.
- ② Category: H-HSG
- ③ Connector type: Blank-ordinary
- ④ Row No.-Pin No per row: XX-Single row
- ⑤ Special No:Blank-Without Ears
- ⑥ Material : 46-PA46 94V-0
- ⑦ Color: Blank-natural GR-Gray

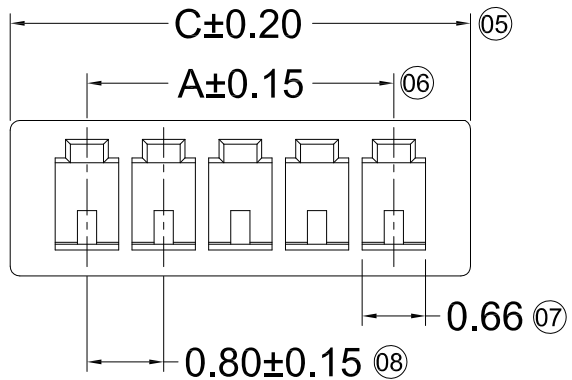

Poles	Dimensions(mm)			Poles	Dimensions(mm)		
	A	B	C		A	B	C
02	0.80	1.80	2.40	12	8.80	9.80	10.40
03	1.60	2.60	3.20	13	9.60	10.60	11.20
04	2.40	3.40	4.00	14	10.40	11.40	12.00
05	3.20	4.20	4.80	15	11.20	12.20	12.80
06	4.00	5.00	5.60	16	12.00	13.00	13.60
07	4.80	5.80	6.40	17	12.80	13.80	14.40
08	5.60	6.60	7.20	18	13.60	14.60	15.20
09	6.40	7.40	8.00	19	14.40	15.40	16.00
10	7.20	8.20	8.80	20	15.20	16.20	16.80
11	8.00	9.00	9.60	22	16.80	17.80	20.40

DATE	REV	ECN NO.	DESCRIPTION	MODIFY	APPROVAL
1					
2					
3					
4					
5					

GENERAL TOLERANCE
.X ±0.30
.XX ±0.20
.XXX ±0.10
X.° ±2°
PROJECT
⊕
⊖



东莞市国亚电子有限公司
 Dong Guan Guo Ya Connectors co., Ltd.

APPROVAL	CHECK	DRAWN	DATE
Yangzhengguo	Yangzhengyi	Lvtiansheng	2016/08/26

PART NO. 0800H-XX-46				
TITLE 0.80mm Crimp Style Commctctors				
UNIT	SCALE	SHEET	REV	NUMBER
mm	1:1	1/1	A0	A-106

RoHS

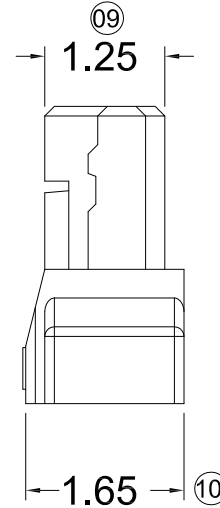
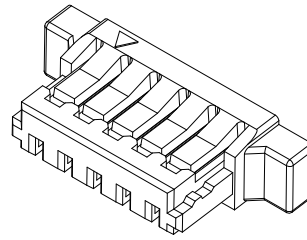
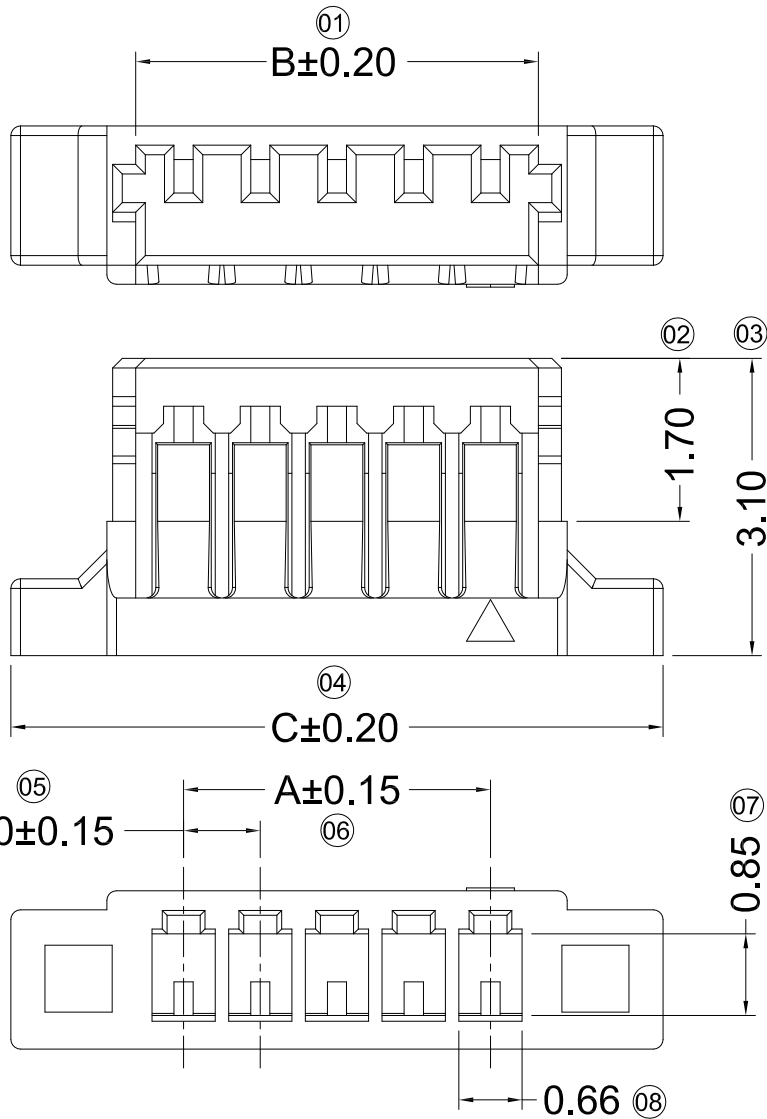

Specifications :

- Voltage rating: 30V AC / DC
- Current rating: 0.50A AC / DC
- Withstanding voltage: 200V AC/minute
- Temperature range: $-40^{\circ} \sim +105^{\circ}$
- Insulation resistance: $\geq 100M\Omega$
- Contact resistance: $\leq 20m\Omega$
- After environmental testing: $\leq 40m\Omega$
- Suitable GYA Terminal: 0800T
- Mates With GYA Wafer: 0800W

0800 H X - XX E - 46 XX

① ② ③ ④ ⑤ ⑥ ⑦

- ① Series No.
- ② Category: H-HSG
- ③ Connector type: Blank-ordinary
- ④ Row No.-Pin No per row: XX-Single row
- ⑤ Special No: E-With Ears
- ⑥ Material : 46-PA46 94V-0
- ⑦ Color: Blank-natural GR-Gray

Poles	Dimensions(mm)			Poles	Dimensions(mm)		
	A	B	C		A	B	C
02	0.80	1.80	4.40	12	8.80	9.80	12.40
03	1.60	2.60	5.20	13	9.60	10.60	13.20
04	2.40	3.40	6.00	14	10.40	11.40	14.00
05	3.20	4.20	6.80	15	11.20	12.20	14.80
06	4.00	5.00	7.60	16	12.00	13.00	15.60
07	4.80	5.80	8.40	17	12.80	13.80	16.40
08	5.60	6.60	9.20	18	13.60	14.60	17.20
09	6.40	7.40	10.00	19	14.40	15.40	18.00
10	7.20	8.20	10.80	20	15.20	16.20	18.80
11	8.00	9.00	11.60	22	16.80	17.80	20.40



DATE	REV	ECN NO.	DESCRIPTION	MODIFY	APPROVAL
1					
2					
3					
4					

GENERAL TOLERANCE

- .X ± 0.30
- .XX ± 0.20
- .XXX ± 0.10
- X. $^{\circ}$ $\pm 2^{\circ}$

PROJECT



东莞市国亚电子有限公司
Dong Guan Guo Ya Connectors co., Ltd.

APPROVAL CHECK DRAWN DATE

Yangzhengguo Yangzhengyi Lvliansheng 2016/08/26

PART NO.
0800H-XXE-46

TITLE 0.80mm Crimp Style Commctctors

UNIT	SCALE	SHEET	REV	NUMBER
mm	1:1	1/1	A0	A-022

RoHS

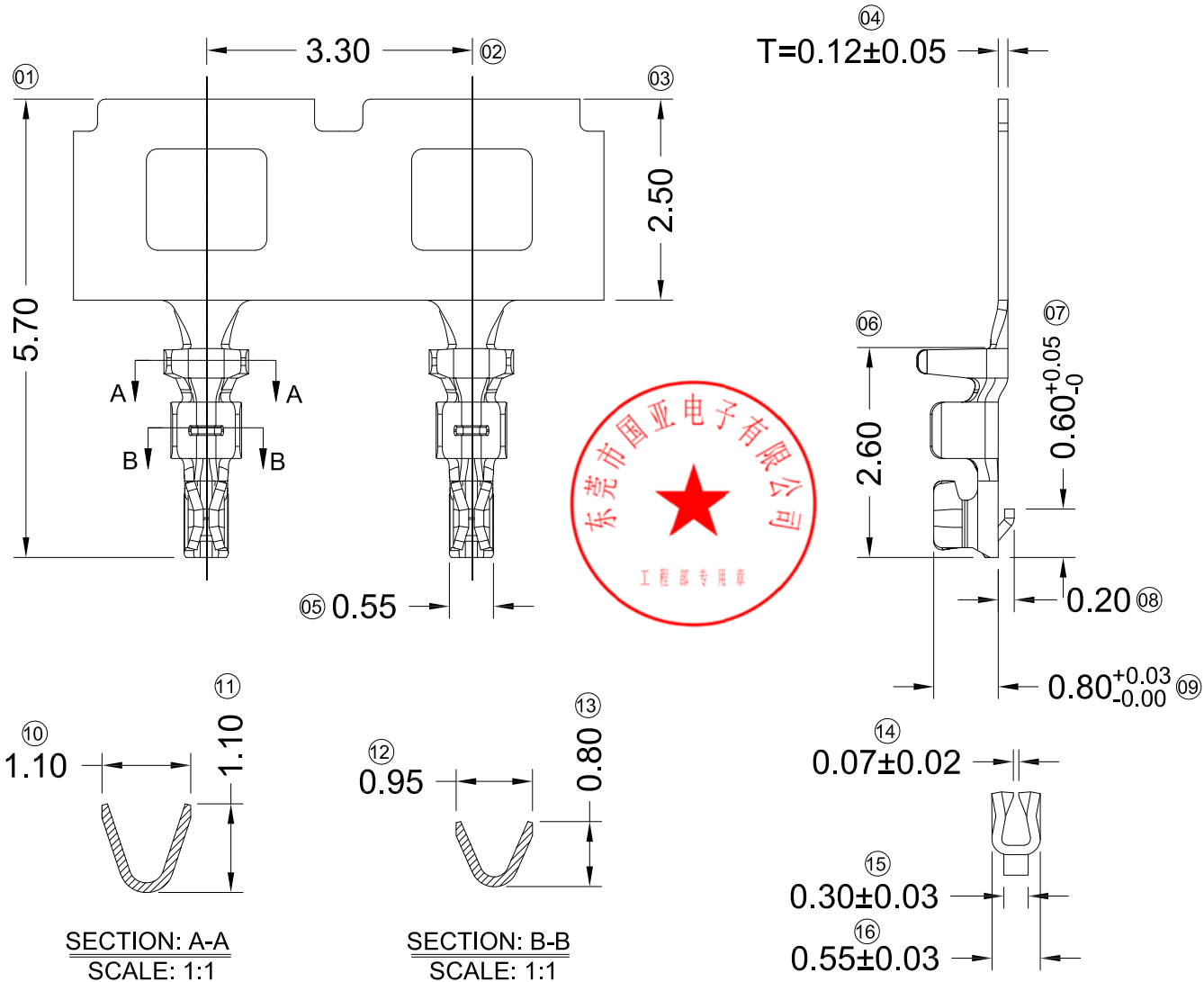

■ Specifications :

- Voltage rating: 30V AC / DC
- Current rating: 0.5A AC / DC
- Withstanding voltage: 200V AC/minute
- Temperature range: -40° ~+105°
- Insulation resistance: ≥100MΩ
- Contact resistance: ≤20mΩ
- After environmental testing: ≤40mΩ
- Wire Range: AWG#32、AWG#30
- Insulation O.D: 0.60mm(Max)
- Used In GYA Housing: 0800H

0800 T X - P XXX X - X
 ① ② ③ ④ ⑤ ⑥ ⑦

- ① Series No
- ② Category: T-terminal
- ③ Shape: Blank-ordinary
- ④ Material: P-Phosphor bronze
- ⑤ Plating Code: SN-Bright tin plating
V01-Gold Flash
- ⑥ Plating method:
Blank-Stamping before plating
- ⑦ Mold No./Mark/Special No.

GENERAL TOLERANCE

.X	±0.30
.XX	±0.20
.XXX	±0.10
X.°	±2°



东莞市国亚电子有限公司
 Dong Guan Guo Ya Connectors co., Ltd.

PART NO.
0800T-PXX

TITLE 0.80mm Crimp Style Connectors

APPROVAL CHECK DRAWN DATE

PROJECT Yangzhengguo Yangzhengyi Lviansheng 2016/08/26

UNIT	SCALE	SHEET	REV	NUMBER
mm	1:1	1/1	A0	A-022

DATE	REV	ECN NO.	DESCRIPTION	MODIFY	APPROVAL
1		2		4	

RoHS

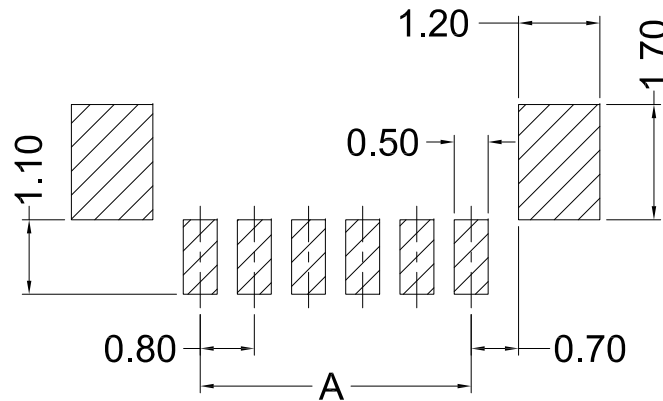
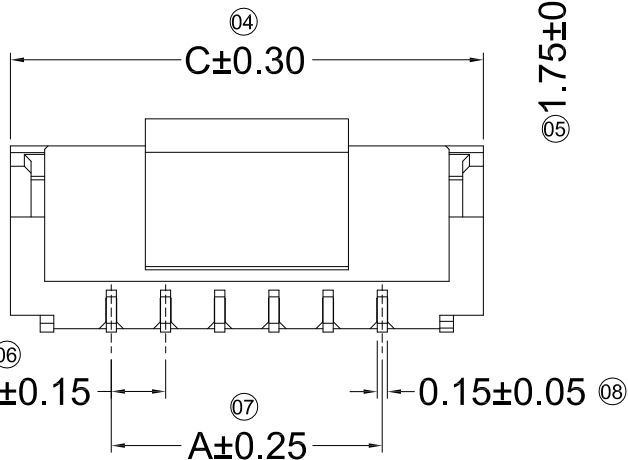
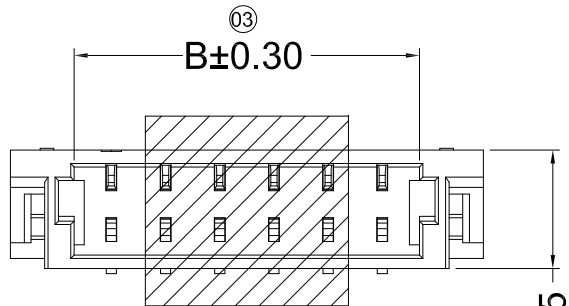
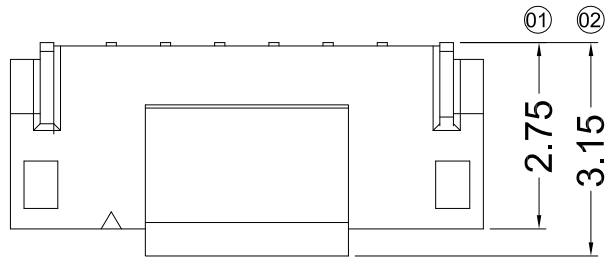

Recommended P.C.B Layout
General Tolerance±0.05

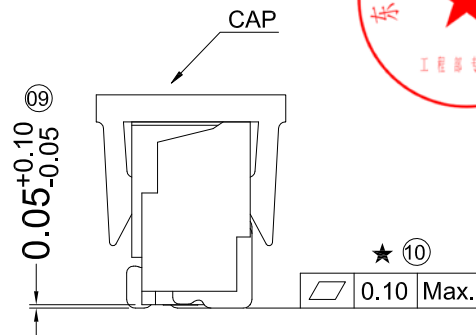

■ Specifications :

- Voltage rating: 30V AC / DC
- Current rating: 0.50A AC / DC
- Withstanding voltage: 200V AC/minute
- Temperature range: -40° ~+105°
- Insulation resistance: ≥100MΩ
- Contact resistance: ≤20mΩ
- After environmental testing: ≤40mΩ
- Material(Pin): Phosphor Bronze
- Material(Solder Tabs): Phosphor Bronze
- Mates With GYA Housing : 0800H

0800 W V S - XX X - LP XX XX
① ②③④ ⑤ ⑥ ⑦ ⑧ ⑨

- ① Series No
- ② Category: W-WAFER
- ③ Connector Type: V-180°
- ④ Mouting Type: S-SMT
- ⑤ Row No.-Pin No.: XX-Single Row
- ⑥ Plug the Pin & Special No.
- ⑦ Material: LP -LCP 94V-0
- ⑧ Plating Code:
V01-All Gold Flash
SN-Bright Tin Plating
- ⑨ Color : Blank-Natural Color

Poles	Dimensions (mm)			Poles	Dimensions (mm)		
	A	B	C		A	B	C
02	0.80	1.90	3.78	12	8.80	9.90	11.78
03	1.60	2.70	4.58	13	9.60	10.70	12.58
04	2.40	3.50	5.38	14	10.40	11.50	13.38
05	3.20	4.30	6.18	15	11.20	12.30	14.18
06	4.00	5.10	6.98	16	12.00	13.10	14.98
07	4.80	5.90	7.78	17	12.80	13.90	15.78
08	5.60	6.70	8.58	18	13.60	14.70	16.58
09	6.40	7.50	9.38	19	14.40	15.50	17.38
10	7.20	8.30	10.18	20	15.20	16.30	18.18
11	8.00	9.10	10.98				

DATE	REV	ECN NO.	DESCRIPTION	MODIFY	APPROVAL
1					
2					
3					
4					
5					

GENERAL TOLERANCE	
.X	±0.30
.XX	±0.20
.XXX	±0.10
X.°	±2°
PROJECT	
⊕	⊖



东莞市国亚电子有限公司
Dong Guan Guo Ya Connectors co., Ltd.

APPROVAL	CHECK	DRAWN	DATE
Yangzhengguo	Yangzhengyi	Lvtiansheng	2016/08/26

PART NO. 0800WVS-XXHF-LPXX				
TITLE 0.80 mm IDC Style Connectors				
UNIT	SCALE	SHEET	REV	NUMBER
mm	1:1	1/1	A0	A-016

RoHS

成品工程图

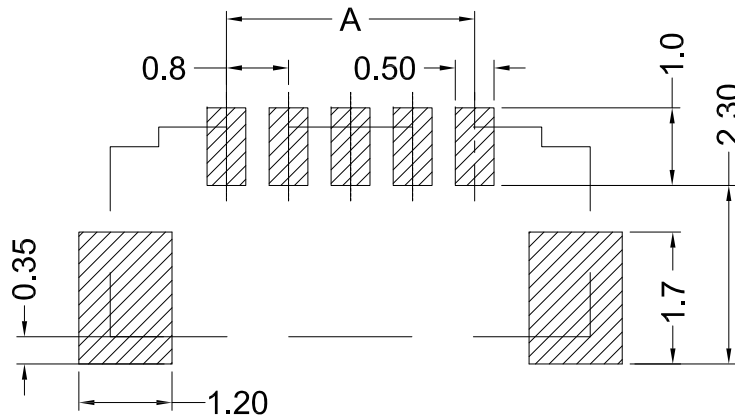
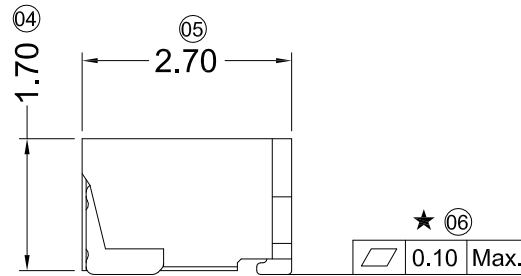
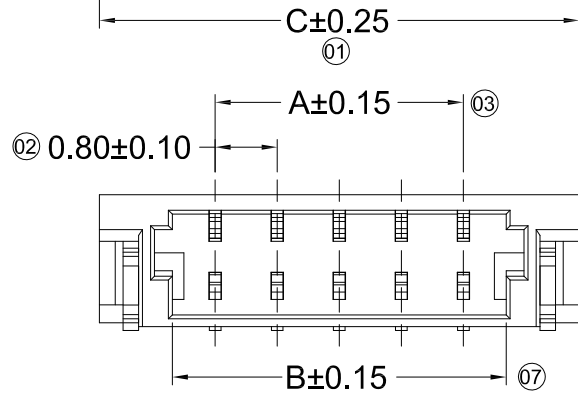
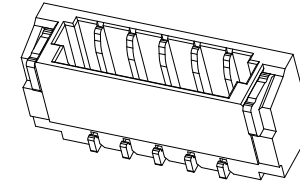

Recommended P.C.B Layout
General Tolerance±0.05

■ Specifications :

- Voltage rating: 30V AC / DC
- Current rating: 0.50A AC / DC
- Withstanding voltage: 200V AC/minute
- Temperature range: -40° ~+105°
- Insulation resistance: ≥100MΩ
- Contact resistance: ≤20mΩ
- After environmental testing: ≤30mΩ
- Material(Pin): Phosphor Bronze
- Material(Solder Tabs): Brass
- Mates With GYA Housing : 0800H

0800 W R S - XX X - XX XX XX

① ② ③ ④ ⑤ ⑥ ⑦ ⑧ ⑨

Poles	Dimensions(mm)			Poles	Dimensions(mm)		
	A	B	C		A	B	C
02	0.80	1.90	3.78	12	8.80	9.90	11.78
03	1.60	2.70	4.58	13	9.60	10.70	12.58
04	2.40	3.50	5.38	14	10.40	11.50	13.38
05	3.20	4.30	6.18	15	11.20	12.30	14.18
06	4.00	5.10	6.98	16	12.00	13.10	14.98
07	4.80	5.90	7.78	17	12.80	13.90	15.78
08	5.60	6.70	8.58	18	13.60	14.70	16.58
09	6.40	7.50	9.38	19	14.40	15.50	17.38
10	7.20	8.30	10.18	20	15.20	16.30	18.18
11	8.00	9.10	10.98				

- ① Series No.
- ② Category: W-wafer
- ③ Connector Type: R-90°
- ④ Mounting Type: S-SMT
- ⑤ Row No.-Pin No. XX-Single row
- ⑥ Special No.: HF-Halogen free
- ⑦ Material: LP-LCP 94V-0 ; 4T-PA4T 94V-0
- ⑧ Plating Code: V01:All Gold-Flash ;
SN-Bright tin plating
- ⑨ Color: Blank-natural color ; BK-black

GENERAL TOLERANCE

- .X ±0.20
- .XX ±0.15
- .XXX ±0.08
- X.° ±2°



东莞市国亚电子有限公司
Dong Guan Guo Ya Connectors co., Ltd.

APPROVAL

CHECK

DRAWN

DATE



Yangzhengguo

Yangzhengyi

Lvtiansheng

2016/08/26

PART NO.

0800WRS-XXHF-XXXX

TITLE

0.80mm IDC Style Connectors

UNIT

SCALE

SHEET

REV

NUMBER

mm

1:1

1/1

A0

A-172

DATE

REV

ECN NO.

DESCRIPTION

MODIFY

APPROVAL

1

2

3

4

5

6

7

8